



SILTEC®

C A B L E H Y G I E N E
C A B L E R O U T I N G S Y S T E M S

WIRE CABLE TRAYS
- locking trays



PRODUCT INFORMATION

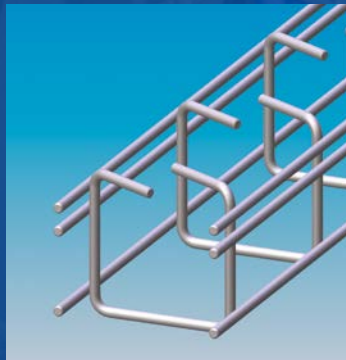

Table of Contents

Locking Cable Trays S20 - S22N, S121-S123	Pgs	4 - 5
Locking Cable Trays K25 - K91	Pgs	6 - 7
Assembly Directions	Pgs	7 - 8
Product Overview	Pgs	10 - 11



SILTEC CABLE ROUTING SYSTEM

SILTEC cable routing system has been developed with optimal function in mind and with emphasis on simplicity and accessibility for the purposes of thorough cleaning and heat dissipation.

SILTEC cable routing system is made up of durable components of steel of highest quality, resistive to corrosion and with excellent chemical resistance.

SILTEC cable routing system is suitable for:

- The Food industry
- The Chemical industry
- Machine builders
- Office and computer environments
- Electrical installations in general

Cable trays are delivered in lengths of 3 meters. Width varies from 25 mm to 600 mm, and height from 25 mm to 125 mm.

Cable trays with custom measurements are made upon request.

All cable trays are made of round material which is gentle on cables, tubing, installers and maintenance personnel.

SILTEC cable trays are produced in

- Stainless steel (Aisi 316 and 304)
- Hot-dip galvanized material
- Electro-galvanized material

SILTEC cable routing system solves issues with the transport of energy in cables – simple, effective and environmentally correct.

SILTEC CABLE ROUTING SYSTEM

- Comes with the following wire cable tray types



Open standard cable trays



Locking cable trays



Open compact trays



Heavy duty cable trays



Cable trays for one layer cable











Cable trays for one cable

In addition, we offer a large number of specialty trays and a comprehensive program of assembly parts, mounts and accessories.

Siltec Locking Cable Trays

Tray Overview

S20		25 x 25 x 3000 mm - ø4 mm 316 St. Steel 570598 610100 4 Hot dip galv. 570598 510100 5 El. pl. Zinc 570598 310100 7
S20N		25 x 25 x 3000 mm - ø4 mm 304 St. Steel 570598 710100 3
S21		50 x 50 x 3000 mm - ø4 mm 316 St. Steel 570598 610101 1 Hot dip galv. 570598 510101 2 El. pl. Zinc 570598 310101 4
S21N		50 x 50 x 3000 mm - ø4 mm 304 St. Steel 570598 710101 0
S22		75 x 75 x 3000 mm - ø4 mm 316 St. Steel 570598 610102 8 Hot dip galv. 570598 510102 9 El. pl. Zinc 570598 310102 1
S22N		75 x 75 x 3000 mm - ø4 mm 304 St. Steel 570598 710102 7
S121		25 x 50 x 3000 mm - ø4 mm 304 St. Steel 570598 710121 8
S123		25 x 100 x 3000 mm - ø4 mm 304 St. Steel 570598 710123 2



S21N

Tray Dimensions

S20:

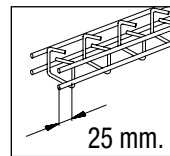



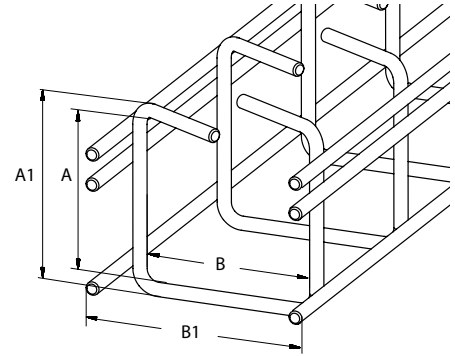
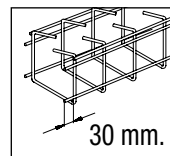



S20N - S22N:

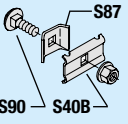
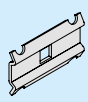
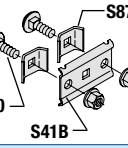
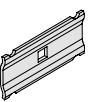
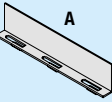
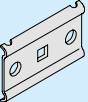

All dimensions in millimeters!

	S20	S20N	S21	S21N	S22	S22N	S121	S123		
A:	27	27	50	50	75	75	30	31		
A1:	33	33	58	58	83	83	36	39		
B:	30	30	50	50	75	75	50	95		
B1:	44	44	66	66	91	91	64	111		

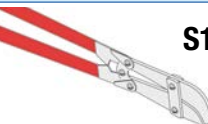
Splice Parts / Mounts

<p>2 x</p>  <p>S40 Splice Kit 316 St. Steel 570598 650501 7 Hot dip galv. 570598 550501 8 El. pl. Zinc 570598 350501 0</p>	 <p>S40B Splice Plate 316 St. Steel 570598 650512 3 Hot dip galv. 570598 550512 4 El. pl. Zinc 570598 350512 6</p>
<p>2 x</p>  <p>S41 Splice Kit 316 St. Steel 570598 650502 4 Hot dip galv. 570598 550502 5 El. pl. Zinc 570598 350502 7</p>	 <p>S40W Splice Plate 316 St. Steel 570598 650514 7</p>
 <p>S85 Divider A: 2000 mm 316 St. Steel 570598 680590 2 Hot dip galv. 570598 580590 3 El. pl. Zinc 570598 380590 5</p>	 <p>S41B Splice Plate 316 St. Steel 570598 650513 0 Hot dip galv. 570598 550513 1 El. pl. Zinc 570598 350513 3</p>
 <p>S87 Splice Washer 316 St. Steel 570598 680596 4 Hot dip galv. 570598 580596 5 El. pl. Zinc 570598 380596 7</p>	 <p>S42 Splice Bracket 316 St. Steel 570598 650508 6 Hot dip galv. 570598 550508 7 El. pl. Zinc 570598 350508 9</p>
 <p>S15 Plastic Caps ø4 mm - black Polypropylene 570598 199621 6</p>	
 <p>S19 Bolt Cutter 570598 210002 5</p>	 <p>S119 Bolt Cutter 570598 210003 2</p>

Ceiling Mounts

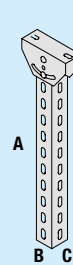

S71 Ceiling Hanger

S71/250
A: 250mm, B: 63 mm, C: 63 mm
316 St. Steel 570598 665571 6

S71/500
A: 500 mm, B: 63 mm, C: 63 mm
316 St. Steel 570598 665571 2
Hot dip galv. 570598 565571 3
El. pl. Zinc 570598 365571 5

S71/750
A: 750mm, B: 63 mm, C: 63 mm
316 St. Steel 570598 665574 3

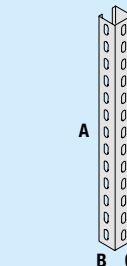

S72 Clg Hanger Extension

A: 1000mm, B: 56 mm, C: 56 mm
Rustf. Aisi 316 570598 665575 0
Galvaniseret 570598 565575 1
Elforzinket 570598 365575 3

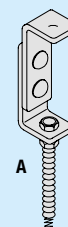









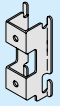
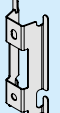

S73 Ceiling Hanger

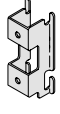
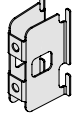
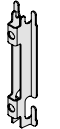
A: 1000 mm
316 St. Steel 570598 665572 9
Hot dip galv. 570598 565572 0
El. pl. Zinc 570598 365572 2

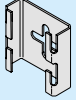
Mounting Brackets

More Assembly Parts, Mounts and Accessories on Pgs 8 - 9

 <p>S46 Mounting Brackets Horizontal A 316 St. Steel 570598 655540 1</p>	 <p>S47 Mounting Brackets Horizontal A 316 St. Steel 570598 655541 8</p>	 <p>S48 Mounting Brackets Horizontal A 316 St. Steel 570598 655542 5</p>	 <p>S157 Mounting Brackets Vertical D 316 St. Steel 570598 655544 9</p>
 <p>S56 Mounting Brackets Vertical D 316 St. Steel 570598 655550 0</p>	 <p>S57 Mounting Brackets Vertical D 316 St. Steel 570598 655551 7</p>	 <p>S155 Mounting Brackets Vertical D 316 St. Steel 570598 650155 2</p>	 <p>S156 Mounting Brackets Vertical D 304 St. Steel 570598 755550 9</p>
 <p>S157 Mounting Brackets Vertical D 304 St. Steel 570598 755551 6</p>	 <p>S45M Mounting Brackets Horizontal A B C 316 St. Steel Hot dip galv. El. pl. Zinc</p> <p>570598 655531 9 570598 555531 0 570598 355531 2</p>	 <p>S14M Mount Polypropylene ø4mm 570598 199611 7</p>	
 <p>S14 Mount Polypropylene ø4 mm 570598 199610 0</p>	 <p>S14BD Mount, detectable Polypropylene ø4 mm 570598 199630 8</p>	 <p>S14MBD Mount, detectable Polypropylene ø4mm 570598 199631 5</p>	

Disposition



	S20	S20N	S21	S21N	S22	S22N	S121	S123		
Splice Parts										
S40	•	•					•	•		
S40B	•	•	•	•	•	•	•	•		
S40W	•									
S41			•	•	•	•				
S41B			•	•	•	•	•	•		
S13	•	•	•	•	•	•	•	•		
S42	•	•	•	•	•	•	•	•		
S85			•	•	•	•				
S87	•	•	•	•	•	•	•	•		
S15	•		•	•	•	•				
Mount										
S71/S72/S73	•	•	•	•	•	•	•	•		
S46	A	A					A	A		
S47			A	A						
S48					A	A				
S50					D	D				
S56	D									
S156		D								
S57			D		D					
S157				D		D	D	D		
S14 / S14BD			A,B	A,B	A,B	A,B		B		
S14M / S14MBD	A,B	A,B					A,B	A		
S155	D									
S155W		D								
S45			A,D	A,D	A,D	A,D				
S45M			A,D	A,D						
S80			A	A	A	A				
S81			A	A	A	A				

Splice Plates S40B, 40W & S41B Applications





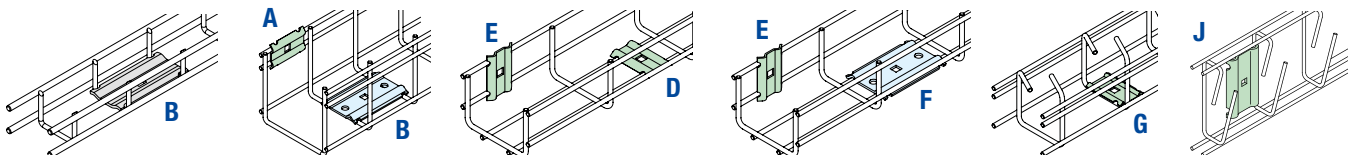



	S20	S20N	S21	S21N	S22	S22N	S121 + S123
S40B	A	A	E, G	E, G	A, G	G, J	A, J
S40W	B	-	-	-	A	-	-
S41B	-	-	A, B	-	B	J	-



Siltec Locking Cable Trays

Tray Overview

K25		25 x 25 x 3000 mm - ø4 mm 304 St. Steel 570598 789104 1
K40		40 x 40 x 3000 mm - ø4 mm 304 St. Steel 570598 789102 7
K90		40 x 90 x 3000 mm - ø4 mm 304 St. Steel 570598 789106 5
K26		25 x 25 x 3000 mm - ø4 mm 304 St. Steel 570598 789105 8 With Welded-On Cover
K41		40 x 40 x 3000 mm - ø4 mm 304 St. Steel 570598 789103 4 With Welded-On Cover
K91		40 x 90 x 3000 mm - ø4 mm 304 St. Steel 570598 789107 2 With Welded-On Cover





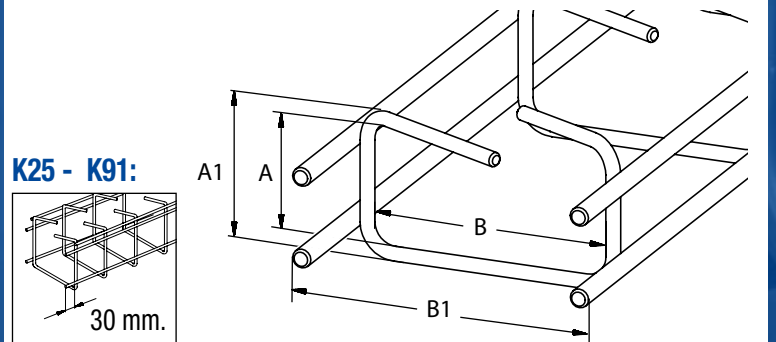

Tray Dimensions







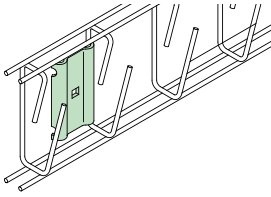

All dimensions in millimeters!





	K25	K40	K90	K26	K41	K91			
A:	28	40	40	28	40	40			
A1:	38	50	52	40	52	53			
B:	29	40	90	29	40	90			
B1:	43	55	105	31	56	108			

Assembly Parts

 <p>S90 Bolt Kit 316 St. Steel 570598 685596 9 Hot dip galv. 570598 585596 0 El. pl. Zinc 570598 385596 2</p>	 <p>S87 Splice Bracket 316 St. Steel 570598 680596 4 Hot dip galv. 570598 580596 5 El. pl. Zinc 570598 380596 7</p>	 <p>S42 Splice Bracket 316 St. Steel 570598 650508 6 Hot dip galv. 570598 550508 7 El. pl. Zinc 570598 350508 9</p>
 <p>S15 Plastic Caps Ø4 mm - black Polypropylene 570598 199621 6</p>	 <p>S40B Splice Plate 316 St. Steel 570598 650512 3 Hot dip galv. 570598 550512 4 El. pl. Zinc 570598 350512 6</p>	<p>Splice Plates S40B Applications</p> 

Mounting Brackets

 <p>S14 Mount Polypropylene 570598 199610 0</p>	 <p>S14BD Mount, detectable Polypropylene 570598 199630 8</p>	 <p>S14M Mount Polypropylene 570598 199611 7</p>	 <p>S14MBD Mount, detectable Polypropylene 570598 199631 5</p>
 <p>S46 Mounting Bracket Horizontal: A 316 St. Steel 570598 655540 1</p>	 <p>S51 Mounting Bracket Horizontal: A 316 St. Steel 570598 655545 6</p>		

Disposition	Horizontal A: 		Horizontal B: 		Horizontal C: 		Vertical D: 	
	K25	K40	K90	K26	K41	K91		
Assembly Parts								
S90	●	●	●	●	●	●		
S40B	●	●	●	●	●	●		
S42	●	●	●	●	●	●		
S87	●	●	●	●	●	●		
Hangers / Mounts								
S71/S72/S73	●							
S14 / S14BD		A	A	A	A	A		
S14M / S14MBD	A,B							
S15	●	●	●	●	●	●		
S46	B	B	B	B	B	B		
S51	B	B	B	B	B	B		

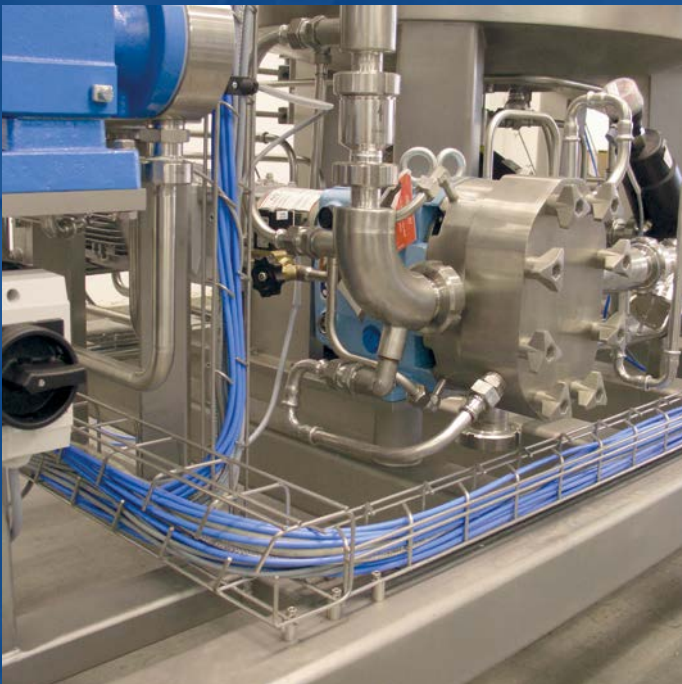

Installation Guide

Tools

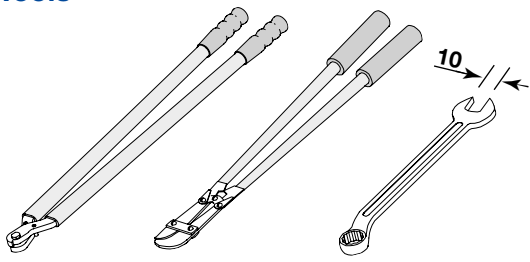

Splicing

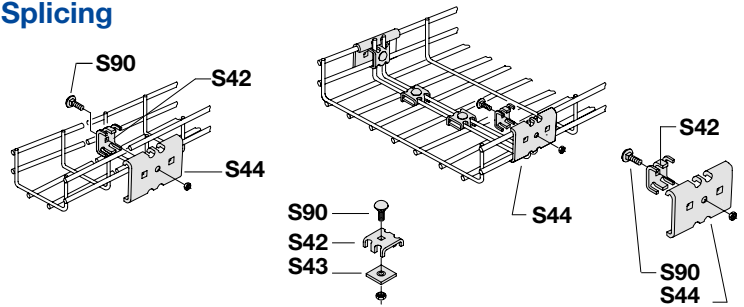

Mounting Options

Horizontal A

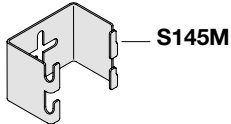
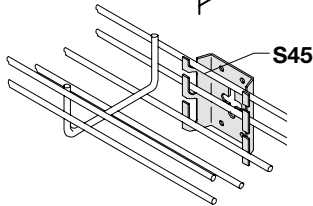
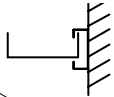

S145M

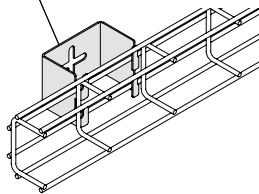

Horizontal B

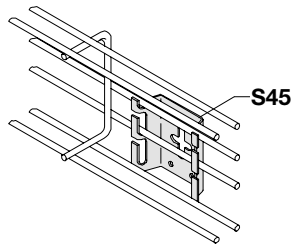

S45

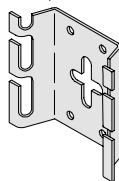

Horizontal C

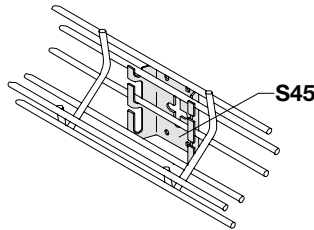
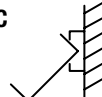

S45

S65-66-67-68

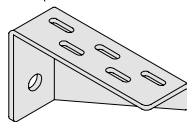

Vertical D

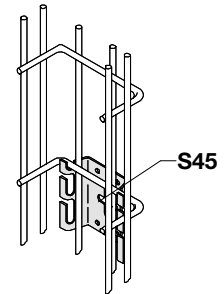

S45

S87

S90

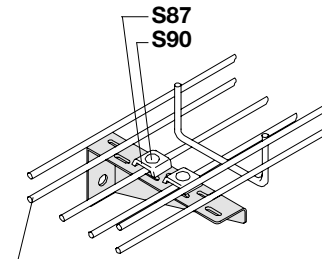

S30-35-36-37-38

Ceiling Hanger

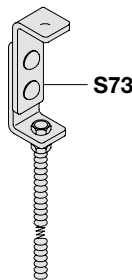
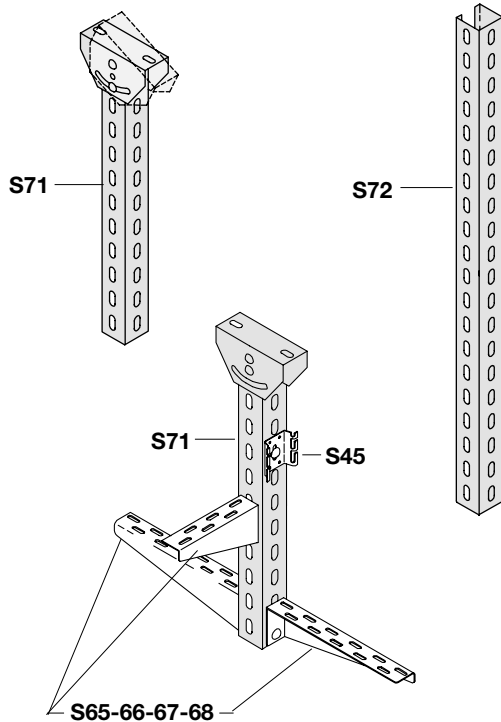

S73

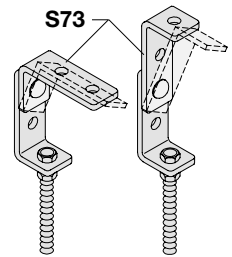

S73

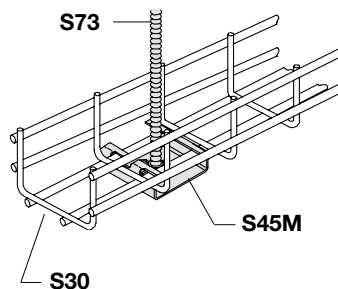

S73

S45M

S30

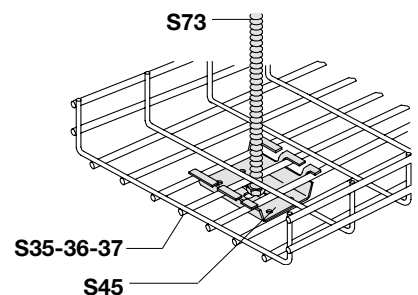

S73

S35-36-37

S45

Wall Mount / Electrical Box Brackets

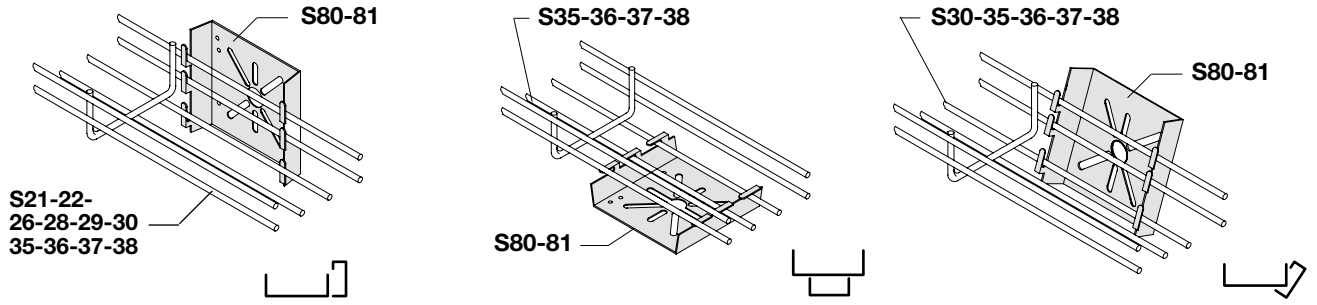

Angle bracket

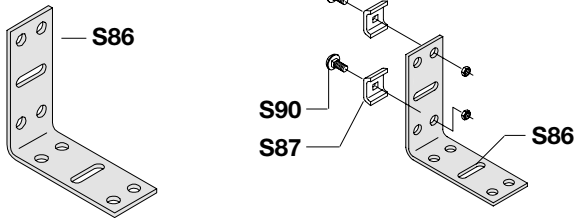

Dividers

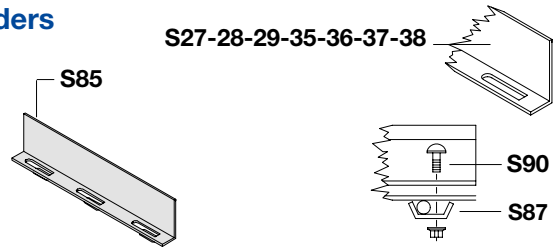

Elbows

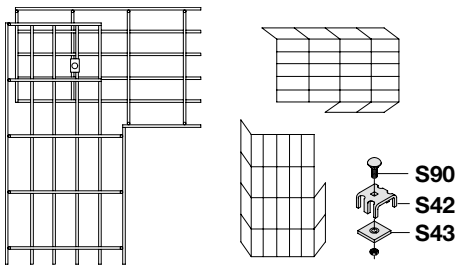

Tees and Crosses

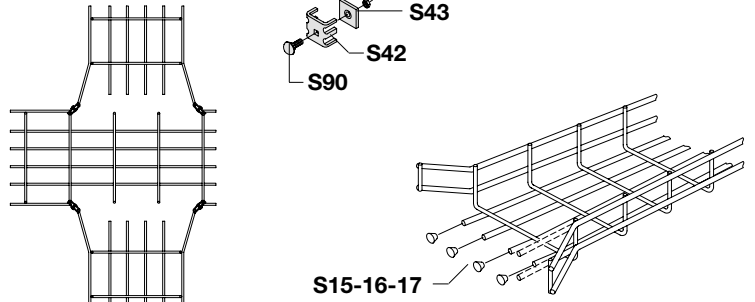

Vertical Bends

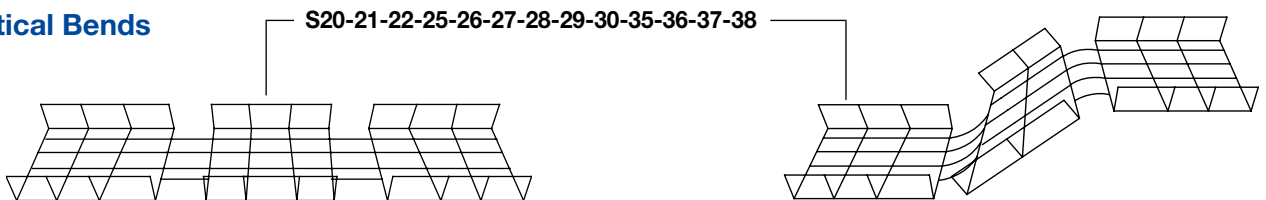



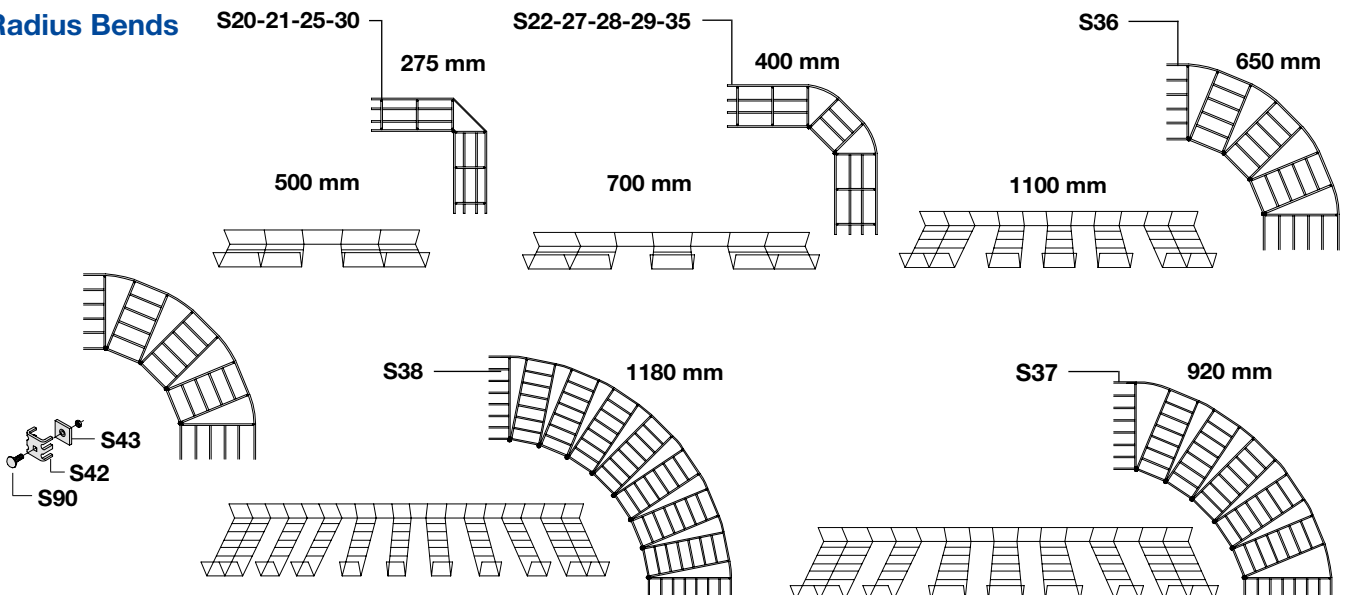







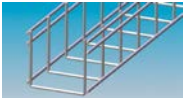



Radius Bends





SILTEC has a Cable Tray for Every Need

Standard - open trays

S25		25 x 25 x 3000 mm - ø4 mm 316 St. Steel 570598 620105 6 304 St. Steel 570598 720105 5 Hot dip galv. 570598 520105 7 El. pl. Zinc 570598 320105 9
S26		50 x 50 x 3000 mm - ø4 mm 316 St. Steel 570598 620106 3 304 St. Steel 570598 720106 2 Hot dip galv. 570598 520106 4 El. pl. Zinc 570598 320106 6
S27		75 x 75 x 3000 mm - ø5 mm 316 St. Steel 570598 620107 0 Hot dip galv. 570598 520107 1 El. pl. Zinc 570598 320107 3
S28		100 x 100 x 3000 mm - ø5 mm 316 St. Steel 570598 620108 7
S30M		35 x 40 x 3000 mm - ø4 mm 316 St. Steel 570598 720117 8 Hot dip galv. 570598 520117 0 El. pl. Zinc 570598 320117 2
S30		45 x 60 x 3000 mm - ø4 mm 316 St. Steel 570598 720118 6 304 St. Steel 570598 720118 5 Hot dip galv. 570598 520118 7 El. pl. Zinc 570598 320118 9
S30*		45 x 60 x 3000 mm - *ø5 mm 316 St. Steel 570598 620119 3 304 St. Steel 570598 720119 2 Hot dip galv. 570598 520119 4 El. pl. Zinc 570598 320119 6
S35		55 x 100 x 3000 mm - ø4 mm 304 St. Steel 570598 720120 8 Hot dip galv. 570598 520120 0 El. pl. Zinc 570598 320120 2
S35*		55 x 100 x 3000 mm - *ø5 mmm 316 St. Steel 570598 640120 3 304 St. Steel 570598 740120 2 Hot dip galv. 570598 540120 4 El. pl. Zinc 570598 340120 6
S35W		55 x 150 x 3000 mm - ø5 mm 316 St. Steel 570598 620120 9 304 St. Steel 570598 720121 5 Hot dip galv. 570598 520121 7 El. pl. Zinc 570598 320121 9
S36		55 x 200 x 3000 mm - ø5 mm 316 St. Steel 570598 640121 0 304 St. Steel 570598 740121 9 Hot dip galv. 570598 540121 1 El. pl. Zinc 570598 340121 3
S37		55 x 300 x 3000 mm - ø5 mm 316 St. Steel 570598 640122 7 304 St. Steel 570598 740122 6 Hot dip galv. 570598 540122 8 El. pl. Zinc 570598 340122 0
S38		55 x 400 x 3000 mm - ø5 mm 316 St. Steel 570598 640123 4 304 St. Steel 570598 740123 3 Hot dip galv. 570598 540123 5 El. pl. Zinc 570598 340123 7
S39		55 x 500 x 3000 mm - ø5 mm 316 St. Steel 570598 640124 1 304 St. Steel 570598 740124 0 Hot dip galv. 570598 540124 2
S39W		55 x 600 x 3000 mm - ø5 mm 304 St. Steel 570598 740126 4 Hot dip galv. 570598 540126 6



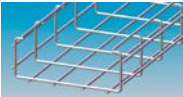







Standard - open trays

S30M-X		50 x 57 x 3000 mm - ø4 mm 304 St. Steel 570598 786175 4
S30-X		70 x 68 x 3000 mm - ø4 mm 304 St. Steel 570598 786180 8
S35-X		70 x 114 x 3000 mm - ø4 mm 304 St. Steel 570598 786181 5
S36-X		70 x 207 x 3000 mm - ø5 mm 304 St. Steel 570598 786185 3

COMPACT Trays







S115		9 x 23 x 3000 mm - ø3 mm 304 St. Steel 570598 720115 4
S116		13 x 30 x 3000 mm - ø3 mm 304 St. Steel 570598 720116 1
S125		8 x 24 x 2800 mm - ø3 mm 316 St. Steel 570598 610105 9
S126		30 x 50 x 3000 mm - ø4 mm 304 St. Steel 570598 790126 9
S127		30 x 75 x 3000 mm - ø4 mm 304 St. Steel 570598 790127 6
S128		30 x 100 x 3000 mm - ø4 mm 304 St. Steel 570598 790128 3
S129		30 x 125 x 3000 mm - ø5 mm 304 St. Steel 570598 790129 0
S130		30 x 150 x 3000 mm - ø5 mm 304 St. Steel 570598 790130 6
S131		30 x 250 x 3000 mm - ø5 mm 304 St. Steel 570598 790131 3
S132		30 x 350 x 3000 mm - ø5 mm 304 St. Steel 570598 790132 0
S133		30 x 450 x 3000 mm - ø5 mm 304 St. Steel 570598 790133 7

Heavy Duty Cable Trays

S235		100 x 100 x 3000 mm - ø5 mm 316 St. Steel 570598 688235 4 Hot dip galv. 570598 588235 5
S236		100 x 200 x 3000 mm - ø5 mm 316 St. Steel 570598 688236 1 Hot dip galv. 570598 588236 2
S237		100 x 300 x 3000 mm - ø5 mm 316 St. Steel 570598 688237 8 Hot dip galv. 570598 588237 9
S238		100 x 400 x 3000 mm - ø5 mm 316 St. Steel 570598 688238 5 Hot dip galv. 570598 588238 6
S239		100 x 500 x 3000 mm - ø5 mm 316 St. Steel 570598 688239 2 Hot dip galv. 570598 588239 3
S240		100 x 600 x 3000 mm - ø5 mm 316 St. Steel 570598 688240 8 Hot dip galv. 570598 588240 9
S428		100 x 100 x 3000 mm - ø5 mm 304 St. Steel 570598 799428 5
S436		100 x 200 x 3000 mm - ø5 mm 304 St. Steel 570598 799436 0
S437		100 x 300 x 3000 mm - ø5 mm 304 St. Steel 570598 799437 7
S438		100 x 400 x 3000 mm - ø5 mm 304 St. Steel 570598 799438 4



Single Cable Trays

S320		5 x 5 x 3000 mm - ø5 mm 316 St. Steel 570598 699320 3
S321		5 x 5 x 3000 mm - ø5 mm 316 St. Steel 570598 699321 0
S322		8 x 8 x 3000 mm - ø5 mm 316 St. Steel 570598 699322 7
S323		10 x 10 x 3000 mm - ø5 mm 316 St. Steel 570598 699323 4
S324		12 x 12 x 3000 mm - ø5 mm 316 St. Steel 570598 699324 1
S325		16 x 16 x 3000 mm - ø5 mm 316 St. Steel 570598 699325 8
S327		27 x 27 x 3000 mm - ø5 mm 316 St. Steel 570598 699327 2

Cable Trays for one layer of cables

S520		8 x 74 x 3000 mm - ø4 mm 304 St. Steel 570598 720520 6
S521		12 x 74 x 3000 mm - ø4 mm 304 St. Steel 570598 720521 3
S522		8 x 114 x 3000 mm - ø4 mm 304 St. Steel 570598 720522 0
S523		12 x 114 x 3000 mm - ø4 mm 304 St. Steel 570598 720523 7
S524		17 x 114 x 3000 mm - ø4 mm 304 St. Steel 570598 720524 4



CABLE HYGIENIC

FUNDER DALGÅRDSVEJ 2-6 . DK-8600 SILKEBORG

TLF: +45 86 85 18 00

www.siltec.dk / siltec@siltec.dk



SILTEC Distributeur Nederland:

CC Nederland B.V.

Facetlaan 4

2665 NR BLEISWIJK

Telefoon: 079 82 000 20

E-mail: info@ccned.nl

Internet: www.ccned.nl