



Programmable Logic Controllers
FC6A



MICROSmart

Manage your production site with
a powerful and simple remote monitoring solution

IDEC CORPORATION

Features

FC6A Plus supports MQTT protocols

- MQTT protocol suitable for a wide variety of IoT applications.
- A gateway is not required. Connects directly to a PLC.
- Supports ID and password authentication as well as certificate based authentication.



FC6A Plus connects to EtherNet/IP™

- Connects to EtherNet/IP™ without exclusive communication modules.
- Communicates with both scanner and adapter devices.



* EtherNet/IP is a registered trademark of ODVA.

Remote control with Web Server function

Use pre-installed, program-less simple pages or design your own custom pages using Web Page Editor.

Wide range of applications

Web server, Send E-mail, FTP server/client, and user communication functions are achieved with the Ethernet communication, enabling to manage the control and information systems at the same time.

New application possibilities

CAN J1939 communication and BACnet/IP protocol available, expanding the possibility of PLC applications.

Bluetooth (Wireless)

PLC can be controlled or monitored from smartphones and tablets using a Bluetooth communication cartridge.

A maximum of 10 racks and 63 expansion modules can be connected.

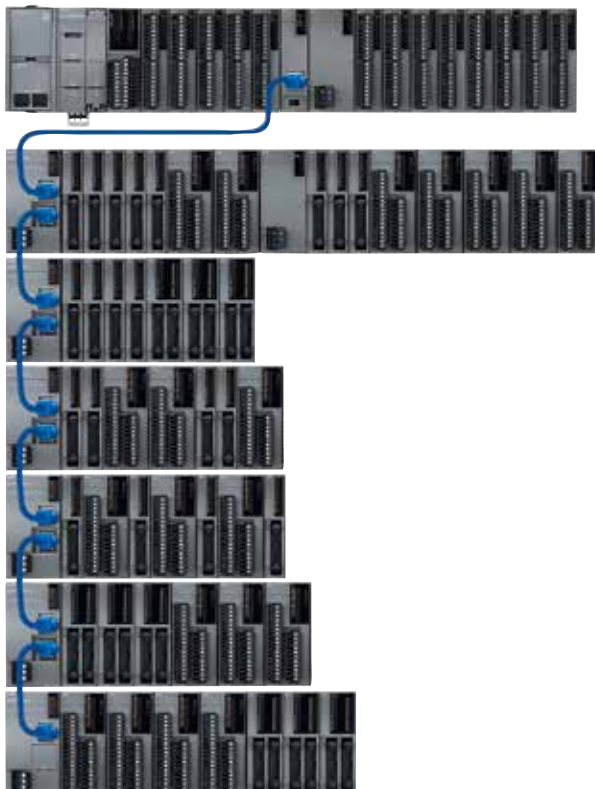

ANSI/ISA 12.12.01 approved for hazardous locations.
 Certified for marine use by Lloyd's Register (LR),
 American Bureau of Shipping (ABS), Det Norske Veritas (DNV),
 and NIPPON KAIJI KYOKAI (NK).

*) Some models are not designed for these certifications.
 Contact IDEC for more details.



Push-in connections are available for all FC6A models.

One step wiring, easy & quick connection. Safe and efficient Push-in connections.



Time saving and efficient

Save up to 55% in wiring time

Wiring time greatly reduced compared with general screw terminals.

*Compared to general screw terminals (Based on IDEC research).

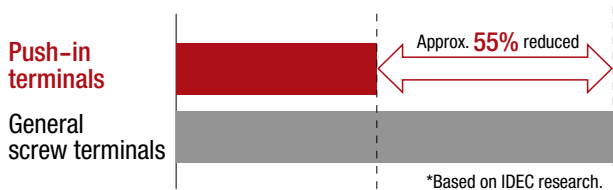

Reliable and easy

Reduce maintenance work

Push-in terminals eliminate the need for torque maintenance such as tightening of screws because screws are not used.

Vibration-resistant

Safe and reliable Push-in connection achieves high contact reliability and vibration resistance regardless of the wire size or shape.

Simple wiring

Work can be performed without using tools and regardless of operators' skill level.

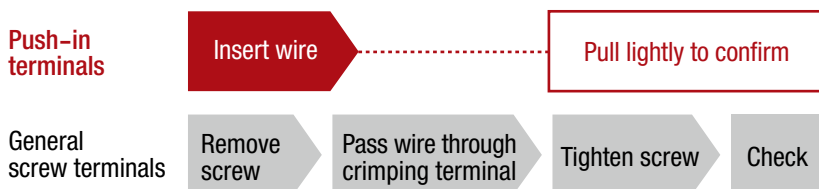

*When ferrule is used.

Lineup

Lineup

Digital Input Modules

Package Quantity: 1

Input Points	Terminal	Part No.
8 points DC	Removable, 5.08mm pitch, 11-pin, screw fastened type connector	FC6A-N08B1
	Removable, 5.08mm pitch, 11-pin, Push-in connector	FC6A-N08B4
16 points DC	Removable, 3.81mm pitch, 10-pin, screw fastened type connector	FC6A-N16B1
	Removable, 3.81mm pitch, 10-pin, Push-in connector	FC6A-N16B4
16 points DC	20-pin MIL connector	FC6A-N16B3
32 points DC		FC6A-N32B3
8 points AC	Removable, 5.08mm pitch, 11-pin, screw fastened type connector	FC6A-N08A11
	Removable, 5.08mm pitch, 11-pin, Push-in connector	FC6A-N08A14

Plus

All-in-One

Modules

Cartridges

Dimensions

Mounting Hole Layout

Instructions

Digital Output Modules

Package Quantity: 1

Output Points	Terminal	Part No.
8 points Relay Output	Removable, 5.08mm pitch, 11-pin, screw fastened type connector	FC6A-R081
	Removable, 5.08mm pitch, 11-pin, Push-in connector	FC6A-R084
16 points Relay Output	Removable, 3.81mm pitch, 10-pin, screw fastened type connector	FC6A-R161
	Removable, 3.81mm pitch, 10-pin, Push-in connector	FC6A-R164
8 points Transistor Sink Output	Removable, 5.08mm pitch, 11-pin, screw fastened type connector	FC6A-T08K1
	Removable, 5.08mm pitch, 11-pin, Push-in connector	FC6A-T08K4
8 points Transistor Source Output	Removable, 5.08mm pitch, 11-pin, screw fastened type connector	FC6A-T08P1
	Removable, 5.08mm pitch, 11-pin, Push-in connector	FC6A-T08P4
16 points Transistor Sink Output	Removable, 3.81mm pitch, 10-pin, screw fastened type connector	FC6A-T16K1
	20-pin MIL connector	FC6A-T16K3
	20-pin Push-in connector	FC6A-T16K4
16 points Transistor Source Output	Removable, 3.81mm pitch, 10-pin, screw fastened type connector	FC6A-T16P1
	20-pin MIL connector	FC6A-T16P3
	20-pin Push-in connector	FC6A-T16P4
32 points Transistor Sink Output	20-pin MIL connector	FC6A-T32K3
32 points Transistor Source Output	20-pin MIL connector	FC6A-T32P3

Digital Mixed I/O Modules

Package Quantity: 1

Input	Input	Output	Terminal	Part No.
8 points Mixed I/O	4 points DC inputs (Sink/Source)	4 relay outputs 240V AC, 2A 30V DC, 2A	Removable, 5.08mm pitch, 11-pin, screw fastened type connector	FC6A-M08BR1
			Removable, 5.08mm pitch, 11-pin, Push-in connector	FC6A-M08BR4
24 points Mixed I/O	16 points DC inputs (Sink/Source)	8 relay outputs 240V AC, 2A 30V DC, 2A	Removable, 3.81mm pitch, 11-pin, screw fastened type connector	FC6A-M24BR1
			Removable, 3.81mm pitch, 17-pin, screw fastened type connector	
			Removable, 3.81mm pitch, 11-pin, Push-in connector	FC6A-M24BR4
			Removable, 3.81mm pitch, 17-pin, Push-in connector	

Lineup		Lineup				Package Quantity: 1
Analog I/O Modules						
Name	Input	Output	I/O Points	Terminal	Part No.	
Analog Input Module	Voltage (0 to 10V, -10 to +10V) Current (0 to 20mA, 4 to 20mA)	—	2 inputs	Removable, 5.08mm pitch, 11-pin, screw fastened type connector	FC6A-J2C1	
				Removable, 5.08mm pitch, 11-pin, Push-in connector	FC6A-J2C4	
			4 inputs	Removable, 3.81mm pitch, 10-pin, screw fastened type connector	FC6A-J4A1	
				Removable, 3.81mm pitch, 10-pin, Push-in connector	FC6A-J4A4	
			8 inputs	Removable, 3.81mm pitch, 10-pin, screw fastened type connector	FC6A-J8A1	
				Removable, 3.81mm pitch, 10-pin, Push-in connector	FC6A-J8A4	
	Voltage (0 to 10V, -10 to +10V) Current (0 to 20mA, 4 to 20mA) Thermocouple (J, K, R, S, B, T, N) Resistance Thermometer (Ni100, Ni1,000, PT100, PT1,000)	—	4 inputs	Removable, 3.81mm pitch, 10-pin, screw fastened type connector	FC6A-J4CN1	
				Removable, 3.81mm pitch, 10-pin, Push-in connector	FC6A-J4CN4	
			Isolated between channels 4 inputs	Removable, 3.81mm pitch, 10-pin, screw fastened type connector	FC6A-J4CH1Y	
				Removable, 3.81mm pitch, 10-pin, Push-in connector	FC6A-J4CH4Y	
Thermocouple (K, J, R, S, B, E, T, N, C)	—	8 inputs	Removable, 3.81mm pitch, 10-pin, screw fastened type connector	FC6A-J8CU1		
			Removable, 3.81mm pitch, 10-pin, Push-in connector	FC6A-J8CU4		
Analog Output Module	—	Voltage (0 to 10V, -10 to +10V) Current (0 to 20mA, 4 to 20mA)	2 outputs	Removable, 5.08mm pitch, 11-pin, screw fastened type connector	FC6A-K2A1	
				Removable, 5.08mm pitch, 11-pin, Push-in connector	FC6A-K2A4	
			4 outputs	Removable, 5.08mm pitch, 11-pin, screw fastened type connector	FC6A-K4A1	
				Removable, 5.08mm pitch, 11-pin, Push-in connector	FC6A-K4A4	
Analog I/O Module	Voltage (0 to 10V, -10 to +10V) Current (0 to 20mA, 4 to 20mA)	Voltage (0 to 10V, -10 to +10V) Current (0 to 20mA, 4 to 20mA)	4 inputs/2 outputs	Removable, 3.81mm pitch, 10-pin, screw fastened type connector	FC6A-L06A1	
				Removable, 3.81mm pitch, 10-pin, Push-in connector	FC6A-L06A4	
	Voltage (0 to 10V, -10 to +10V) Current (0 to 20mA, 4 to 20mA) Thermocouple (K, J, R, S, B, E, T, N, C) Resistance Thermometer (Ni100, Ni1,000, PT100, PT1,000)		2 inputs/1 output	Removable, 5.08mm pitch, 11-pin, screw fastened type connector	FC6A-L03CN1	
				Removable, 5.08mm pitch, 11-pin, Push-in connector	FC6A-L03CN4	

Analog I/O Modules (PID)						
Name	Input	Output	I/O Points	Terminal	Part No.	
PID Module	Voltage (0-1V, 0-5V, 1-5V, 0-10V) Current (0-20mA, 4-20mA) Thermocouple (K, J, R, S, B, E, T, N, PL-II, C) Resistance Thermometer (PT100, JPT100)	Relay output	2 analog inputs 2 relay outputs	Removable, 3.81mm pitch 11-pin, screw fastened type connector	FC6A-F2MR1	
				Removable, 5.08mm pitch, 17-pin, screw fastened type connector	FC6A-F2MR4	
		Voltage output (12V, transistor protect source output) Current (4 to 20mA, analog output)	2 analog inputs 2 analog/digital outputs	Removable, 3.81mm pitch 11-pin, screw fastened type connector	FC6A-F2M1	
				Removable, 5.08mm pitch, 17-pin, screw fastened type connector	FC6A-F2M4	
				Removable, 3.81mm pitch 11-pin, Push-in connector	FC6A-F2M4	
				Removable, 5.08mm pitch, 17-pin, Push-in connector	FC6A-F2M4	

Lineup

Lineup

HMI Module

Package Quantity: 1

Name	Connectable CPU Module			Part No.
	Plus	All-in-One	CAN J1939 All-in-One	
HMI Module	Yes	Yes	Yes	FC6A-PH1

Plus

All-in-One

Modules

Cartridges

Dimensions

Mounting Hole Layout

Instructions

Expansion Interface Module

Package Quantity: 1

Name	Connectable CPU Module			Terminal	Part No.
	Plus	All-in-One	CAN J1939 All-in-One		
Unibody Type	Yes	Yes	Yes	Removable, 5.08mm pitch, screw fastened type connector	FC6A-EXM2
				Removable, 5.08mm pitch, Push-in connector	FC6A-EXM24
Separate Master Type	Yes	No	No		FC6A-EXM1M
Separate Slave Type	Yes	No	No	Removable, 5.08mm pitch, screw fastened type connector	FC6A-EXM1S
				Removable, 5.08mm pitch, Push-in connector	FC6A-EXM1S4

Communication Module

Package Quantity: 1

Name	Connectable CPU Module			Terminal	Part No.
	Plus	All-in-One	J1939 All-in-One		
RS232C/RS485 Communication Module	Yes	Yes	Yes	Removable, 3.81mm pitch, 10-pin, screw fastened type connector	FC6A-SIF52
				Removable, 3.81mm pitch, 10-pin, Push-in connector	FC6A-SIF524

Communication Cartridges

Package Quantity: 1

Name	Connectable CPU Module			Part No.
	Plus	All-in-One	CAN J1939 All-in-One	
RS232C	Yes (*1)	Yes	Yes	FC6A-PC1
RS485	Yes (*1)	Yes	Yes	FC6A-PC3
Bluetooth	Yes (*1)	Yes	Yes	FC6A-PC4

Digital I/O Cartridges

Package Quantity: 1

Name	Connectable CPU Module			I/O Points	Part No.
	Plus	All-in-One	CAN J1939 All-in-One		
Digital Input	Yes (*1)	Yes	Yes	4 inputs	FC6A-PN4
Digital Output	Yes (*1)	Yes	Yes	4 transistor sink outputs	FC6A-PTK4
	Yes (*1)	Yes	Yes	4 transistor source outputs	FC6A-PTS4

Analog I/O Cartridges

Package Quantity: 1

Name	Connectable CPU Module			I/O Points	Part No.
	Plus	All-in-One	CAN J1939 All-in-One		
Analog Voltage/Current Input	Yes (*1)	Yes	Yes	2 inputs	FC6A-PJ2A
Analog Temperature Input					FC6A-PJ2CP
Analog Voltage Output	Yes (*1)	Yes	Yes	2 outputs	FC6A-PK2AV
Analog Current Output					FC6A-PK2AW

Cartridge Base Module

Package Quantity: 1

Name	Connectable CPU Module			Part No.
	Plus	All-in-One	CAN J1939 All-in-One	
Cartridge Base Module	Yes	No	No	FC6A-HPH1

Programming Software

Package Quantity: 1

Name	Part No.
Application Software Automation Organizer Ver. 3.90 or higher WindLDR V.8.6 or higher	SW1A-W1C

*1) When a cartridge base module is added to the left of CPU.

Lineup	Lineup				
Plus	Option				
All-in-One	Name	Description	Part No.	Package Quantity	
Modules	Plus CPU Module Terminal Block Connector	3.81mm pitch, 10-pin, screw fastened type for FC6A-D16□□CEE	FC6A-PMTCN10PN02		
Cartridges		3.81mm pitch, 11-pin, screw fastened type for FC6A-D16R□CEE	FC6A-PMTCR11PN02		
Dimensions		3.81mm pitch, 11-pin, screw fastened type for FC6A-D16K□CEE	FC6A-PMTCK11PN02		
Mounting Hole Layout		3.81mm pitch, 11-pin, screw fastened type for FC6A-D16P□CEE	FC6A-PMTCP11PN02		
Instructions		3.81mm pitch, 10-pin, Push-in type for FC6A-D16□□CEE	FC6A-PMSCN10PN02		
		3.81mm pitch, 11-pin, Push-in type for FC6A-D16R□CEE	FC6A-PMSCR11PN02		
		3.81mm pitch, 11-pin, Push-in type for FC6A-D16K□CEE	FC6A-PMSCK11PN02		
		3.81mm pitch, 11-pin, Push-in type for FC6A-D16P□CEE	FC6A-PMSCP11PN02		
Terminal Block Connector for All-in-One CPU Module/ CAN J1939 All-in-One CPU Module	5.08mm pitch, 8-pin, screw fastened type for FC6A-C24□□□E	FC6A-PMTA08PN02	2		
	5.08mm pitch, 9-pin, screw fastened type all CPU modules	FC6A-PMTA09PN02			
	5.08mm pitch, 10-pin, screw fastened type for FC6A-C40□□□E□	FC6A-PMTA10PN02			
	5.08mm pitch, 12-pin, screw fastened type for FC6A-C16□□□E	FC6A-PMTA12PN02			
	5.08mm pitch, 13-pin, screw fastened type for FC6A-C24□□□E	FC6A-PMTA13PN02			
	5.08mm pitch, 8-pin, Push-in type for FC6A-C24□□□E	FC6A-PMSCA08PN02			
	5.08mm pitch, 9-pin, Push-in type all CPU modules	FC6A-PMSCA09PN02			
	5.08mm pitch, 10-pin, Push-in type for FC6A-C40□□□E□	FC6A-PMSCA10PN02			
	5.08mm pitch, 12-pin, Push-in type for FC6A-C16□□□E	FC6A-PMSCA12PN02			
	5.08mm pitch, 13-pin, Push-in type for FC6A-C24□□□E	FC6A-PMSCA13PN02			
CAN J1939 All-in-One CAN Communication Terminal Block Connector	5.08mm pitch, 5-pin, screw fastened type	FC6A-PMTE05PN02	2		
	5.08mm pitch, 5-pin, Push-in type	FC6A-PMSE05PN02			
Expansion Interface Module Terminal Block Connector	5.08mm pitch, 11-pin, screw fastened type	FC6A-PMTB11PN02	5		
	5.08mm pitch, 11-pin, Push-in type	FC6A-PMTB11PN02			
	3.81mm pitch, 10-pin, screw fastened type	FC6A-PMTC10PN02			
	3.81mm pitch, 11-pin, screw fastened type	FC6A-PMTC11PN02			
	3.81mm pitch, 17-pin, screw fastened type	FC6A-PMTC17PN02			
	3.81mm pitch, 10-pin, Push-in type	FC6A-PMSC10PN02			
	3.81mm pitch, 11-pin, Push-in type	FC6A-PMSC11PN02			
	3.81mm pitch, 17-pin, Push-in type	FC6A-PMSC17PN02			
MIL Connector for Plus CPU Module/Expansion Module	20-pin MIL connector	FC4A-PMC20PN02	10		
FC6A CPU Module Power Supply Terminal Block Connector	5.08mm pitch, 3-pin, screw fastened type	FC6A-PMTD03PN02			
	5.08mm pitch, 3-pin, Push-in (For Plus / All-in-One CPU Module, 24V DC)	FC6A-PMSDC03PN02			
	5.08mm pitch, 3-pin, Push-in (For All-in-One CPU Module, 12V DC)	FC6A-PMSDD03PN02			
Expansion Interface Module Power Supply Terminal Block Connector for FC6A-EXM2/-EXM1S	5.08mm pitch, 3-pin, Push-in (For All-in-One CPU Module, AC)	FC6A-PMSDA03PN02			
	5.08mm pitch, 3-pin, screw fastened type	FC6A-PMTB03PN02			
CPU Module Connector with Analog Input Cable	Connector: UL1977 compliant, Wire: UL758 style 1007 compliant	FC6A-PMSC03PN02		5	
CPU Module Battery Holder		FC4A-PMAC2PN02			
CPU Module Mounting Hook	Can be used with HMI module	FC6A-BH1PN02		5	
Expansion Module Mounting Hook	Can be used with expansion interface module	FC6A-PSP1PN05			
35-mm-wide DIN Rail	Aluminium, 1m	FC6A-PSP2PN05	10		
End Clip		BAA1000PN10			
USB Maintenance Cable	2m long, USB-mini B	BNL6PN10	10		
USB-mini B Port Extension Cable	1m long, USB-mini B	HG9Z-XCM42			
CPU Module Replacement Battery	Coin-Shaped Manganese Dioxide Lithium Battery CR2032W (One battery is supplied)	HG9Z-XCE21			
I/O Communication Cable	For connecting HG4G/3G/2G, external device, and general-purpose operator interface to MicroSmart (5m) RJ45 connector: loose wire RJ45 connector: UL1863 compliant Wire: UL758 style 20276 compliant	FC6A-KC1C			
	For connecting HG4G/3G/2G to MicroSmart: D-sub 9-pin (5m) RJ45 connector: D-sub 9-pin connector RJ45 connector: UL1863 compliant Wire: UL758 style 20276 compliant D-sub connector plastic: UL94-V0	FC6A-KC2C			
I/O Terminal Cable	20-pin	Shielded Wire: UL758 style 20266 compliant MIL connector plastic: UL94-V0	0.5m	FC9Z-H050A20	1
			1m	FC9Z-H100A20	
			2m	FC9Z-H200A20	
		Non-shielded Wire: UL758 style 2651 compliant MIL connector plastic: UL94-V0	3m	FC9Z-H300A20	
			0.5m	FC9Z-H050B20	
			1m	FC9Z-H100B20	
Instruction Manual	User's Manual	Japanese	FC9Z-H200B20		
		English	FC9Z-H300B20		
		Simplified Chinese (PDF)	FC9Y-B1721		
	Ladder Programming	Japanese	FC9Y-B1722		
		English	FC9Y-B1723		
		Simplified Chinese (PDF)	FC9Y-B1725		
	All-in-One Plus Communication	Japanese	FC9Y-B1726		
		English	FC9Y-B1727		
		Simplified Chinese (PDF)	FC9Y-B1729		
PID Module	Japanese	FC9Y-B1730			
	English	FC9Y-B1731			
	Simplified Chinese (PDF)	FC9Y-B1733			
			FC9Y-B1734		

Note: MicroSmart User's manual and other manuals applicable to Automation Organizer can be downloaded from <http://www.idec.com/language>.

Operating Conditions

Ambient Operating Temperature	-10 to +55 (*1) (no freezing)	
Expanded Ambient Operating Temperature	-25 to -10°C, +55 to +65°C (*2) (*3) (no freezing)	
Ambient Storage Temperature	-25 to +70°C (no freezing)	
Relative Humidity	10 to 95%, no condensation	
Storage Humidity	10 to 95%, no condensation	
Pollution Degree	2 (IEC60664-1)	
Degree of Protection	IP20 (IEC60529)	
Atmosphere	No corrosive gas	
Altitude or Air Pressure	1,013 to 795 hPa (0 to 2,000 m) during operation	
	1,013 to 701 hPa (0 to 3,000 m) during transport	
Installation Location	Inside cabinet	
Device Class	Open equipment	
Overvoltage Category	II	
Vibration Resistance	DIN Rail Mount	5 to 8.4 Hz half amplitude 3.5 mm, 8.4 to 150 Hz, acceleration 9.8 m/s ² (1 G), each direction XYZ, 2 hours (IEC/EN 61131-2)
	Panel Mount	
Shock Resistance	147 m/s ² (15 G), 11 ms, XYZ, 3 axes, 6 directions, 3 times each (IEC 61131-2)	
EMC Immunity	IEC/EN61131-2, Zone B compatibility	

*1) The HMI module (FC6A-PH1) is 0 to 55°C.

*2) Expanded ambient operating temperature is for versions as shown below.

All-in-One CPU Modules	: HV200 or higher
CAN J1939 CPU Modules	: HV200 or higher
Plus CPU Modules	: HV200 or higher
Digital I/O Modules	: V300 or higher
Analog I/O Modules (FC6A-J2C□, -J4A□, -J8A□, -L03CN□, -J4CN□)	: V300 or higher
Analog I/O Modules (FC6A-K2A□, -J8CU□, -J4CH□Y)	: V200 or higher
Expansion Interface Modules	: V200 or higher
Communication Module	: V200 or higher

*3) HMI module (FC6A-PH1), Cartridge Base Module (FC6A-HPH1), Cartridge (FC6A-PTK4□, -PTS4, -PN4, -PJ2A, -RJ2CP, -PK2AV, -PK2AW, -PC1, -PC3, -PC4), PID module (FC6A-F2M□, -F2MR□), and some Analog I/O Modules (FC6A-K4A□, -L06A□) cannot be used under the expanded ambient operating temperature.

Note: Specify a terminal type code in place of □ in the Part No.

1: screw fastened type, 4: Push-in type

Lineup

Plus

All-in-One

Modules

Cartridges

Dimensions

Mounting Hole Layout

Instructions

Lineup **Plus CPU Modules**

Plus **Specifications**

	Part No.	FC6A-D16R□CEE FC6A-D16P□CEE FC6A-D16K□CEE	FC6A-D32P□CEE FC6A-D32K□CEE
All-in-One	Rated Power Voltage	24V DC	
Modules	Allowable Voltage Range	20.4 to 28.8V DC (including ripple)	
Cartridges	Maximum Power Consumption (CPU module)	FC6A-D16R□CEE: 2.88W (24V DC) FC6A-D16P□CEE: 2.88W (24V DC) FC6A-D16K□CEE: 2.88W (24V DC) FC6A-D32P□CEE: 3.36W (24V DC) FC6A-D32K□CEE: 3.36W (24V DC)	
Dimensions	Inrush Current	35A maximum	
Mounting Hole Layout	Allowable Momentary Power Interruption	10 ms (at rated voltage)	
Instructions	Dielectric Strength	Between power and FE terminals: 500V AC, 1 minute Between transistor output and FE terminals: 500V AC, 1 minute Between power and input terminals: 500V AC, 1 minute Between power and relay output terminals: 2,300V AC, 1 minute Between input and relay output terminals: 2,300V AC, 1 minute Between input and FE terminals: 500V AC, 1 minute Between relay output and FE terminals: 2,300V AC, 1 minute Between power and transistor output terminals: 500V AC, 1 minute Between input and transistor output terminals: 500V AC, 1 minute	
	Insulation Resistance	Between power and FE terminals: 100 MΩ or higher (500V DC megger) Between transistor output and FE terminals: 100MΩ or higher (500V DC megger) Between power and input terminals: 100 MΩ or higher (500V DC megger) Between power and relay output terminals: 100 MΩ or higher (500V DC megger) Between input and relay output terminals: 100 MΩ or higher (500V DC megger) Between input and FE terminals: 100 MΩ or higher (500V DC megger) Between relay output and FE terminals: 100 MΩ or higher (500V DC megger) Between power and transistor output terminals: 100 MΩ or higher (500V DC megger) Between input and transistor output terminals: 100 MΩ or higher (500V DC megger)	
	Power Supply Wire	UL1007 AWG24-16, UL2464 AWG24-16, UL1015 AWG20-16	
	Grounding Wire	UL1007 AWG16	
	Ground	D-type ground (Class 3 ground)	
	Mounting	DIN rail or panel mounting	
	Weight (approx.)	FC6A-D16R1CEE: 290g FC6A-D16P1CEE: 275g FC6A-D16K1CEE: 275g	FC6A-D16R4CEE: 280g FC6A-D16P4CEE: 265g FC6A-D16K4CEE: 265g FC6A-D32P3CEE: 255g FC6A-D32K3CEE: 255g FC6A-D32P4CEE: 255g FC6A-D32K4CEE: 255g

Note: Specify a terminal type code in place of □ in the Part No. (1: screw fastened type, 3: MIL connector type, 4: Push-in type)

Note: For operating conditions, see page 9.

Plus CPU Modules

Lineup

Plus

All-in-One

Modules

Cartridges

Dimensions

Mounting Hole Layout

Instructions

Function Specifications

Note: Limited number of output points can be turned on.
The upper limit varies on the expanded ambient operating temperature (-25 to -10°C, +55 to +65°C).

Part No.		FC6A-D16R□CEE FC6A-D16P□CEE (*4) FC6A-D16K□CEE (*4)	FC6A-D32P□CEE (*4) FC6A-D32K□CEE (*4)
Control System	Stored program system		
Instruction Words	Basic	42	
	Advanced	130	
Program Capacity (*1)	800KB (100,000 steps)		
User Program Download	1,000 times		
Processing Time	Basic Instruction	21µs/1,000 steps	
	END Processing (*2)	1ms maximum	
I/O Points	Input	8 points	16 points
	Output	8 points	16 points
Expansion Module	Expandable Modules	7 modules (*3)	
	Expandable I/O Points	224 points	
Expansion Interface Module	Unibody Type Expandable Modules	8 modules	
	Unibody Type Expandable I/O Points	256 points	
	Separate Type Expandable Modules (*5)	63 modules (separate type master: 1 module maximum, separate type slave: 10 modules maximum)	
	Separate Type Expandable I/O Points (*5)	2,016 points	
Internal Relay	15,400 points		
Special Internal Relay	1,600 points		
Shift Register	256 points		
Data Register	60,000 points		
Non-Retentive Data Register	200,000 points		
Special Data Register	900 points		
Counter	512 points		
Timer (1ms, 10ms, 100ms, 1s)	2,000 points		
Clock	Clock accuracy: ±30 sec/month (typical) at 25°C		
RAM Backup	Backup Data	RAM (internal relay, shift register, counter, data register), clock data (*9)	
	Battery (enclosed with product)	Lithium primary battery (part number of enclosed batteries cannot be selected) Panasonic: BR2032 / CR2032A / CR2032B Murata: CR2032X / CR2032W	
	Battery Life	1-year warranty (replacement approx. 4 years (+25°C)) (*10)	
	Replaceability	Replace within one minute after power off (recommended) (*6)	
Self-diagnostic Function	Keep data, user program (ROM) CRC check, timer/counter preset value change check, user program syntax check, user program execution check, watchdog timer check, user program download check, power failure, clock error, data link connection check, expansion bus initialization check, system check, SD memory card transfer check, SD memory card access check		
Input Filter	0 ms (without filter), 3 to 15ms (selectable in increments of 1ms) I14, I15, I16, I17: 3ms		
Catch Input/Interrupt Input	Six inputs I0, I1, I3, I4, I6, I7 (Minimum turn on pulse width: 5µs max./Minimum turn off pulse width: 5µs max.)		
High-speed Counter	Maximum Counting Frequency and High-speed Counter Points	Total 6 points Single/two-phase selectable: 100 kHz (single-phase: 6 points, two-phase: 3 points)	
	Counting Range	0 to 4,294,967,295 (32 bits)	
	Operation Mode	Rotary encoder mode, adding counter mode, frequency measurement mode	
Analog Potentiometer	Quantity	1 point	
	Data Range	0 to 1,000	
Analog Voltage Input	Quantity	1 point	
	Input Voltage Range	0 to 10V	
	Input Impedance	Approx. 100KΩ	
	Digital Resolution	Approx. 4,000 steps (12 bits)	
Pulse Output (transistor output model only)	Quantity	4 points	
	Maximum Output Pulse Frequency	Q0, Q2, Q4, Q6: 100kHz	
	Reversible Control	Single-pulse output mode: 4 axis (Q0-Q7), Dual-pulse output mode: 4 axis (Q0-Q7)	
	PWM Output	Duty cycle 0.1 to 100.0% (increments of 0.1%), Output pulse frequency 15 to 5,000 Hz (increments of 1 Hz): 4 points (Q0, Q2, Q4, Q6) (Adjust 5µs minimum as ON time and 15µs minimum as OFF time.)	
USB Port	USB mini-B (maintenance communication)		
Ethernet Port 1	Maintenance communication (server), user communication TCP (server/client), user communication UDP, Modbus TCP (server/client), Email, Web Server, PING, SNMP, FTP server/client, BACnet/IP, MQTT (*7)		
Ethernet Port 2	Maintenance communication (server), user communication TCP (server/client), user communication UDP, Modbus TCP (server/client), PING, EtherNet/IP™		
Cartridge (option) (*8)	Two cartridges can be added (when using FC6A-HPH1)/One cartridge can be added (when using FC6A-PH1)		
SD Card Slot	Embedded		
HMI Module (option) (*8)	Yes		

Note: Specify a terminal type code in place of □ in the Part No. (1: screw fastened type, 3: MIL connector type, 4: Push-in type)

*1) 1 step equals 8 bytes. *2) Not including expansion I/O service time, counter timer processing time, data link processing time, and interrupt processing time.

*3) A maximum of 5 modules can be connected when using the expansion interface module separate type master. *4) Transistor output model

*5) Communication module cannot be connected. *6) Batteries can be replaced when power is on or replaced while power is supplied from USB bus power

*7) Plus CPU module System software Ver. 1.20 or later. (Included in WindLDR Ver. 8.90 in Automation Organizer Ver. 3.12.0 or later)

*8) Cartridges and HMI Modules cannot be used under the expanded ambient operating temperature (-25 to -10°C, +55 to +65°C).

*9) RAM backup data can be saved in a non-volatile memory using the SD card receive function.

*10) 1-year warranty conditions include operating environments (temperature/humidity) during power off and power on.

Lineup **Plus CPU Modules**

Plus **Specifications**

All-in-One **USB Port**

Modules	Part No.	FC6A-D16R□CEE / FC6A-D16P□CEE / FC6A-D16K□CEE	FC6A-D32P□CEE / FC6A-D32K□CEE
Cartridges	USB Type	USB mini-B	
	USB Standard	USB 2.0	
	Isolation	Not isolated from the internal circuit	
Dimensions	Communication Function	Maintenance communication to PC	

Note: Specify a terminal type code in place of □ in the Part No. (1: screw fastened type, 3: MIL connector type, 4: Push-in type)

Mounting Hole Layout **Ethernet Port 1**

Instructions	Part No.	FC6A-D16R□CEE / FC6A-D16P□CEE / FC6A-D16K□CEE	FC6A-D32P□CEE / FC6A-D32K□CEE
	Communication Type	IEEE802.3 compliant	
	Communication Speed	10BASE-T, 100BASE-TX	
	Connector	RJ45	
	Cable	CAT. 5 or higher STP	
	Maximum Cable Length	100m	
	Isolation	Pulse transformer isolation	
	Communication Function	Maintenance communication (server), user communication (server/client), user communication UDP, Modbus TCP (server/client), Email, Web Server, PING, SNMP, FTP server/client, BACnet/IP, MQTT	

Note: Specify a terminal type code in place of □ in the Part No. (1: screw fastened type, 3: MIL connector type, 4: Push-in type)

Ethernet Port 2

	Part No.	FC6A-D16R□CEE / FC6A-D16P□CEE / FC6A-D16K□CEE	FC6A-D32P□CEE / FC6A-D32K□CEE
	Communication Type	IEEE802.3 compliant	
	Communication Speed	10BASE-T, 100BASE-TX	
	Connector	RJ45	
	Cable	CAT. 5 or higher STP	
	Maximum Cable Length	100m	
	Isolation	Pulse transformer isolation	
	Communication Function	Maintenance communication (server), user communication (server/client), user communication UDP, Modbus TCP (server/client), PING, EtherNet/IP™	

Note: Specify a terminal type code in place of □ in the Part No. (1: screw fastened type, 3: MIL connector type, 4: Push-in type)

BACnet/IP

	Part No.	FC6A-D16R□CEE / FC6A-D16P□CEE / FC6A-D16K□CEE	FC6A-D32P□CEE / FC6A-D32K□CEE
	Supported Port	Ethernet Port 1	
	Applicable Standards	ANSI/ASHRAE135-2012	
Standard Specifications	Protocol	BACnet/IP	
	Profile	B-ASC	
	Object Type	Device Object, Analog Input Object, Analog Output Object, Analog Value Object, Binary Input Object, Binary Output Object, Binary Value Object	
	Number of Objects	256 maximum (*1)	
	BIBBs	DS-RP-B, DS-WP-B, DS-RPM-B, DS-WPM-B, DS-COV-B, DS-COVU-B, DM-DDB-B, DM-DDB-B, DM-DCC-B	
	BBMD	None-BBMD Device	
	Virtual Device	No	
Subscribed COV Function	Foreign Device	Yes	
	Number of Requests That Can Be Accepted	256 requests maximum	
Unsubscribed COV Function	Transmission Unit	Every object	
	Transmission Cycle	1 to 65,535 [ms] (*2)	
Foreign Device Function	Registration Method	Registration as needed by registration trigger device	
	Lifetime	0 to 65,535 [s]	
Device Binding Function		<ul style="list-style-type: none"> • Synchronization between properties and devices (*3) • Data type conversion of Present_Value (*4) • Coefficient conversion of Present_Value (*4) 	

Note: Specify a terminal type code in place of □ in the Part No. (1: screw fastened type, 3: MIL connector type, 4: Push-in type)

*1) Device Object is not included. *2) The transmission cycle is set for all objects. *3) The properties of objects created in internal memory are synchronized with specified devices. *4) Supported objects are Analog Input Object, Analog Output Object, and Analog Value Object.

Plus CPU Modules

Lineup

Plus

All-in-One

Modules

Cartridges

Dimensions

Mounting Hole Layout

Instructions

Input

Part No.	FC6A-D16R□CEE / FC6A-D16P□CEE / FC6A-D16K□CEE		FC6A-D32P□CEE / FC6A-D32K□CEE	
Input Points	8 (8/1 common)		16 (16/1 common)	
Rated Input Voltage	24V DC: 24V DC sink/source input signal			
Input Voltage Range	0 to 28.8V DC			
Rated Input Current	High speed input port 5mA/pt, middle/normal speed input port 7mA/pt			
Input Impedance	High speed input port 4.9kΩ, middle/normal speed input port: 3.4kΩ			
Input Delay	Turn ON Time	High speed input port: 5μs + filter value Middle speed input port: 35μs + filter value Normal speed input port: 4.1ms		
	Turn OFF Time	High speed input port: 5us + filter value Middle speed input port: 35us + filter value Normal speed input port: 4.1ms		
Isolation	Between input terminals: Not isolated Internal circuit: Optocoupler-isolated			
Input Type	Type1 (IEC 61131-2)			
External Load for I/O Interconnection	Not needed			
Signal Determination Method	Static			
Effect of Improper Input Connection	Both sinking and sourcing input signals can be connected, therefore reverse connection does not cause damage. If any input exceeding the rated value is applied, permanent damage may be caused.			
Cable Length	3m in compliance with electromagnetic immunity			
Connector	Insertion Durability	100 times		

Note: Specify a terminal type code in place of □ in the Part No. (1: screw fastened type, 3: MIL connector type, 4: Push-in type)

Relay Output

Part No.	FC6A-D16R□CEE		
Relay Output Points	8		
Output Points per Common Line	COM1	4	
	COM2	4	
Output Type	1NO		
Maximum Load Current	Per Point	2A	
	Per Common	COM1: 7A COM2: 7A	
Minimum Switching Load	1mA/5V DC (reference value)		
Initial Contact Resistance	30 mΩ maximum		
Electrical Life	100,000 operations minimum (rated resistive load 1,800 operations/hour)		
Mechanical Life	20,000,000 operations minimum (no load 18,000 operations/hour)		
Rated Load	Resistive load: 240V AC 2A, 30V DC 2A Inductive load: 240V AC 2A (cos θ = 0.4), 30V DC 2A (L/R = 7 ms)		
Connector	Insertion Durability	100 times	

Note: Specify a terminal type code in place of □ in the Part No. (1: screw fastened type, 4: Push-in type)

Transistor Output

Part No.	FC6A-D16P□CEE / FC6A-D16K□CEE		FC6A-D32P□CEE / FC6A-D32K□CEE	
Transistor Output Points	8 (8/1 common)		16 (16/1 common)	
Output Type	Transistor Sink	FC6A-D16K□CEE / FC6A-D32K□CEE		
	Transistor Source	FC6A-D16P□CEE / FC6A-D32P□CEE		
Rated Load Voltage	24V DC			
Voltage Tolerance	19.2 to 28.8V DC			
Rated Load Current	Per Point	0.5A	0.1A	
	Per Common	4.0A	1.6A	
Output Delay	Turn ON Time	High speed input port: 5μs Normal speed input port: 300μs		
	Turn OFF Time	High speed input port: 5μs Normal speed input port: 300μs		
Isolation	Between output terminal and Internal circuit: Optocoupler-isolated Between output terminals: Not isolated			
Voltage Drop (ON Voltage)	1V max (voltage between COM and output terminal when output is on.)			
Inrush Current	1A		0.2A	
Leakage Current	0.1mA maximum			
Clamping Voltage	39V ±1V			
Maximum Lamp Load	12W		2.4W	
Inductive Load	L/R=10ms (28.8V DC, 1Hz)			
Overcurrent Protection	Transistor Sink Output: No Transistor Source Output: Overcurrent is detected by current limit resistance. (*1)			
External Current Draw	100mA maximum, 24V DC (power voltage at the +V terminal, -V terminal at source)			
Connector	Insertion Durability	100 times		

Note: Specify a terminal type code in place of □ in the Part No. (1: screw fastened type, 3: MIL connector type, 4: Push-in type)

*1) This overcurrent signals consist of one signal per 4 point outputs. When microprocessor gets this overcurrent signal by interrupt input, microprocessor turns off 4pt outputs of this category at fixed time (approx. 1sec).

Lineup All-in-One / CAN J1939 All-in-One CPU Modules

Plus

Specifications

Part No.	FC6A-C16R□AE FC6A-C16R□CE FC6A-C16P□CE FC6A-C16K□CE FC6A-C16R□DE FC6A-C16P□DE FC6A-C16K□DE	FC6A-C24R□AE FC6A-C24R□CE FC6A-C24P□CE FC6A-C24K□CE	FC6A-C40R□AE FC6A-C40R□CE FC6A-C40P□CE FC6A-C40K□CE FC6A-C40R□DE FC6A-C40P□DE FC6A-C40K□DE	FC6A-C40R□AEJ FC6A-C40R□CEJ FC6A-C40P□CEJ FC6A-C40K□CEJ FC6A-C40R□DEJ FC6A-C40P□DEJ FC6A-C40K□DEJ
Rated Power Voltage	AC: 100 to 240V AC, DC: 24V DC, 12V DC			
Allowable Voltage Range	AC: 85 to 264V AC 24V DC: 20.4 to 28.8V DC (including ripple), 12V DC: 10.2 to 18.0V			
Rated Frequency	AC: 50/60Hz (47 to 63 Hz)			
Maximum Power Consumption (CPU module)	AC	FC6A-C16R□AE: 100-240V AC, 33VA FC6A-C24R□AE: 100-240V AC, 35VA	FC6A-C40R□AE: 100-240V AC, 41VA FC6A-C40R□AEJ: 100-240V AC, 37VA	
	DC	FC6A-C16R□CE: 24V DC 140mA, 3.36W FC6A-C24R□CE: 24V DC 155mA, 3.72W FC6A-C40R□CE: 24V DC 195mA, 4.68W FC6A-C16P□CE: 24V DC 190mA, 4.6W FC6A-C24P□CE: 24V DC 200mA, 4.8W FC6A-C40P□CE: 24V DC 205mA, 5.0W FC6A-C16K□CE: 24V DC 190mA, 4.6W FC6A-C24K□CE: 24V DC 200mA, 4.8W	FC6A-C40K□CE: 24V DC 205mA, 5.0W FC6A-C16R□DE: 12V DC 270mA, 3.24W FC6A-C40R□DE: 12V DC 345mA, 4.14W FC6A-C16P□DE: 12V DC 260mA, 3.12W FC6A-C40P□DE: 12V DC 260mA, 3.12W FC6A-C16K□DE: 12V DC 250mA, 3.0W FC6A-C40K□DE: 12V DC 260mA, 3.12W FC6A-C40R□CEJ: 24V DC 205mA, 5.0W FC6A-C40P□CEJ: 24V DC 175mA, 4.2W FC6A-C40K□CEJ: 24V DC 175mA, 4.2W FC6A-C40R□DEJ: 12V DC 340mA, 4.08W FC6A-C40P□DEJ: 12V DC 320mA, 3.9W FC6A-C40K□DEJ: 12V DC 320mA, 3.9W	
Inrush Current	AC: 40A maximum 24V DC: 35A maximum 12V DC: 35A maximum			
Allowable Momentary Power Interruption	10 ms (at rated voltage)			
Dielectric Strength	AC	Between power and PE terminals: 1,500V AC, 1 minute Between relay output and PE terminals: 2,300V AC, 1 minute Between power and relay output terminals: 2,300V AC, 1 minute	Between input and PE terminals: 1,500V AC, 1 minute Between power and input terminals: 1,500V AC, 1 minute Between input and relay output terminals: 2,300V AC, 1 minute	
	DC	Between power and FE terminals: 500V AC, 1 minute Between transistor output and FE terminals: 500V AC, 1 minute Between power and input terminals: 500V AC, 1 minute Between power and relay output terminals: 2,300V AC, 1 minute Between input and relay output terminals: 2,300V AC, 1 minute	Between input and FE terminals: 500V AC, 1 minute Between relay output and FE terminals: 2,300V AC, 1 minute Between power and transistor output terminals: 500V AC, 1 minute Between input and transistor output terminals: 500V AC, 1 minute	
Insulation Resistance	AC	Between power and PE terminals: 100 MΩ or higher (500V DC megger) Between relay output and PE terminals: 100 MΩ or higher (500V DC megger) Between power and relay output terminals: 100 MΩ or higher (500V DC megger)	Between input and PE terminals: 100 MΩ or higher (500V DC megger) Between power and input terminals: 100 MΩ or higher (500V DC megger) Between input and relay output terminals: 100 MΩ or higher (500V DC megger)	
	DC	Between power and FE terminals: 100 MΩ or higher (500V DC megger) Between transistor output and FE terminals: 100 MΩ or higher (500V DC megger) Between power and input terminals: 100 MΩ or higher (500V DC megger) Between power and relay output terminals: 100 MΩ or higher (500V DC megger) Between input and relay output terminals: 100 MΩ or higher (500V DC megger)	Between input and FE terminals: 100 MΩ or higher (500V DC megger) Between relay output and PE terminals: 100 MΩ or higher (500V DC megger) Between power and transistor output terminals: 100 MΩ or higher (500V DC megger) Between input and transistor output terminals: 100 MΩ or higher (500V DC megger)	
Power Supply Wire	UL1007 AWG24-16, UL2464 AWG24-16, UL1015 AWG20-16			
Grounding Wire	UL1007, AWG16			
Ground	D-type ground (Class 3 ground)			
Mounting	DIN rail or panel mounting			
Weight	FC6A-C16R1AE: 370g FC6A-C16R4AE: 370g FC6A-C16R1CE: 360g FC6A-C16R4CE: 360g FC6A-C16P1CE: 340g FC6A-C16P4CE: 340g FC6A-C16K1CE: 340g FC6A-C16K4CE: 340g FC6A-C16R1DE: 350g FC6A-C16R4DE: 350g FC6A-C16P1DE: 340g FC6A-C16P4DE: 340g FC6A-C16K1DE: 340g FC6A-C16K4DE: 340g	FC6A-C24R1AE: 420g FC6A-C24R4AE: 420g FC6A-C24R1CE: 400g FC6A-C24R4CE: 400g FC6A-C24P1CE: 380g FC6A-C24P4CE: 380g FC6A-C24K1CE: 380g FC6A-C24K4CE: 380g	FC6A-C40R1AE: 560g FC6A-C40R4AE: 565g FC6A-C40R1CE: 530g FC6A-C40R4CE: 535g FC6A-C40P1CE: 480g FC6A-C40P4CE: 485g FC6A-C40K1CE: 480g FC6A-C40K4CE: 485g FC6A-C40R1DE: 560g FC6A-C40R4DE: 565g FC6A-C40P1DE: 530g FC6A-C40P4DE: 535g FC6A-C40K1DE: 530g FC6A-C40K4DE: 535g	FC6A-C40R1AEJ: 560g FC6A-C40R4AEJ: 555g FC6A-C40R1CEJ: 530g FC6A-C40R4CEJ: 525g FC6A-C40P1CEJ: 480g FC6A-C40P4CEJ: 475g FC6A-C40K1CEJ: 480g FC6A-C40K4CEJ: 475g FC6A-C40R1DEJ: 560g FC6A-C40R4DEJ: 555g FC6A-C40P1DEJ: 530g FC6A-C40P4DEJ: 525g FC6A-C40K1DEJ: 530g FC6A-C40K4DEJ: 525g

Note: Specify a terminal type code in place of □ in the Part No. (1: screw fastened type, 4: Push-in type)
Note: For operating conditions, see page 9.

All-in-One / CAN J1939 All-in-One CPU Modules

Function Specifications

Note: The maximum number of relay outputs that can be turned on simultaneously is limited.
The upper limit varies on the expanded ambient operating temperature (-25 to -10°C, +55 to +65°C).

Part No.	FC6A-C16R□AE FC6A-C16R□CE FC6A-C16P□CE (*5) FC6A-C16K□CE (*5) FC6A-C16R□DE FC6A-C16P□DE (*5) FC6A-C16K□DE (*5)	FC6A-C24R□AE FC6A-C24R□CE FC6A-C24P□CE (*5) FC6A-C24K□CE (*5)	FC6A-C40R□AE FC6A-C40R□CE FC6A-C40P□CE (*5) FC6A-C40K□CE (*5) FC6A-C40R□DE FC6A-C40P□DE (*5) FC6A-C40K□DE (*5)	FC6A-C40R□AEJ FC6A-C40R□CEJ FC6A-C40P□CEJ (*5) FC6A-C40K□CEJ (*5) FC6A-C40R□DEJ FC6A-C40P□DEJ (*5) FC6A-C40K□DEJ (*5)
Control System	Stored program system			
Instruction Words	Basic	42		
	Advanced	129		
Program Capacity (*1)	384KB (48,000 steps)/72KB (9,000 steps) (*2)			640KB (80,000 steps) 72KB (9,000 steps) (*2)
User Program Download	1,000 times			
Processing Time	Basic Instruction	42µs/1,000 steps		
	END Processing (*3)	1ms maximum		
I/O Points	Input	9 points	14 points	24 points
	Output	7 points	10 points	16 points
Expandable Modules	4 modules		7 modules	
Expandable I/O Points with Expansion Modules	128 points		224 points	
Expandable Modules with Unibody Type Expansion Interface Modules	8 modules			
Expandable I/O Points with Expansion Interface Modules	256 points			
Internal Relay	12,400 points			
Special Internal Relay	256 points			
Shift Register	256 points			
Data Register	54,000 points			
Special Data Register	500 points			
Counter	512 points			
Timer (1ms, 10ms, 100ms, 1s)	1,024 points			
Clock	Clock accuracy: ±30 sec/month (typical) at 25°C			
RAM Backup	Backup Data	RAM (internal relay, shift register, counter, data register), clock data (*9)		
	Battery (enclosed with products)	Lithium primary battery (part number of enclosed batteries cannot be selected) Panasonic: BR2032 / CR2032A / CR2032B Murata: CR2032X / CR2032W		
	Battery Life	1-year warranty (replacement approx. 4 years (+25°C)) (*10)		
	Replaceability	Replace within one minute after power off (recommended) (*6)		
Self-diagnostic Function	Keep data, user program (ROM) CRC check, timer/counter preset value change check, user program syntax check, user program execution check, watchdog timer check, user program download check, power failure, clock error, data link connection check, expansion bus initialization check, system check, SD memory card transfer check, SD memory card access check			
Input Filter	0 ms (without filter), 3 to 15ms (selectable in increments of 1ms)			
Catch Input/Interrupt Input	Six inputs I0, I1, I6, I7 (Minimum turn on pulse width: 5µs max., Minimum turn off pulse width: 5µs max.) I3, I4 (Minimum turn on pulse width: 35µs max., Minimum turn off pulse width: 35µs max.)			
High-speed Counter	Maximum Counting Frequency and High-speed Counter Points	Total 6 points Single/two-phase selectable: 100 kHz (single-phase: 4 points, two-phase: 2 points) Single-phase: 5 kHz (2 points)		
	Counting Range	0 to 4,294,967,295 (32 bits)		
	Operation Mode	Rotary encoder mode, adding counter mode, frequency measurement mode		
Analog Potentiometer	Quantity	1 point		—
	Data Range	0 to 1,000		—
Analog Voltage Input	Quantity	1 point		—
	Input Voltage Range	0 to 10V		—
	Input Impedance	Approx. 100KΩ		—
	Digital Resolution	Approx. 1,000 steps (10 bits)		—
Pulse Output (transistor output model only)	Quantity	4 points		—
	Maximum Output Pulse Frequency	Q0, Q1: 100 kHz Q2, Q3: 5 kHz		Q0, Q2, Q4, Q6: 100 kHz
	Reversible Control	Single-pulse output mode: 2 axis (Q0-Q3) Dual-pulse output mode: 1 axis (Q0-Q1)		Single-pulse output mode: 4 axis (Q0-Q7) Dual-pulse output mode: 4 axis (Q0-Q7)
	PWM Output	Duty cycle 0.1 to 100.0% (increments of 0.1%) Output pulse frequency 15 to 5,000 (increments of 1 Hz): 4 points (Q0-Q3) *Q0, Q1: Adjust 5µs minimum as ON time and 15µs minimum as OFF time. *Q2, Q3: Adjust 100µs minimum as ON/OFF time.		Dual cycle: 0.1 to 100.0% (increments of 0.1%) Output pulse frequency: 15 to 5,000 (increments of 1 Hz): 4 points (Q0, Q2, Q4, Q6) * Adjust 5µs minimum as ON time and 15µs minimum as OFF time.
External Power Supply for Sensor (*8) (AC only)	Output Voltage/Current	24V (+10%, -15%) / 250mA		
	Overload Detection	Not possible		
	Isolation from the internal circuit	Transformer-isolated		
USB Port	USB mini-B (maintenance communication)			
Serial Port 1, CAN Port	RS232C or RS485 (*4)			CAN J1939
Ethernet Port 1	Ethernet (maintenance communication, user communication, Modbus TCP server/client)			
SD Card Slot	Embedded (*7)			
Cartridge (option) (*8)	One cartridge can be added on CPU module One cartridge can be added on HMI module (FC6A-PH1)		Two cartridges can be added on CPU module One cartridge can be added on HMI module (FC6A-PH1)	
HMI Module (option) (*8)	Yes	Yes	Yes	Yes

Note: Specify a terminal type code in place of □ in the Part No. (1: screw fastened type, 4: Push-in type)

*1) 1 step equals 8 bytes. *2) When 72KB is selected, download function can be used during RUN.

*3) Not including expansion I/O service time, counter timer processing time, data link processing time, and interrupt processing time.

*4) Maintenance communication, user communication, data link, Modbus RTU master/slave communication. *5) Transistor output model

*6) Batteries can be replaced when power is on or replaced while power is supplied from USB bus power *7) SD memory cards (max 2 GB), SDHC memory cards (max 32 GB)

*8) External power supplies for sensor, cartridges and HMI Modules cannot be used under the expanded ambient operating temperature (-25 to -10°C, +55 to +65°C).

*9) RAM backup data can be saved in a non-volatile memory using the SD card receipt function.

*10) 1-year warranty conditions include operating environments (temperature/humidity) during power off and power on.

Lineup

Plus

All-in-One

Modules

Cartridges

Dimensions

Mounting Hole Layout

Instructions

Lineup All-in-One / CAN J1939 All-in-One CPU Modules

Specifications

USB Port

Part No.	FC6A-C16R□AE FC6A-C16R□CE FC6A-C16P□CE FC6A-C16K□CE FC6A-C16R□DE FC6A-C16P□DE FC6A-C16K□DE	FC6A-C24R□AE FC6A-C24R□CE FC6A-C24P□CE FC6A-C24K□CE	FC6A-C40R□AE FC6A-C40R□CE FC6A-C40P□CE FC6A-C40K□CE FC6A-C40R□DE FC6A-C40P□DE FC6A-C40K□DE	FC6A-C40R□AEJ FC6A-C40R□CEJ FC6A-C40P□CEJ FC6A-C40K□CEJ FC6A-C40R□DEJ FC6A-C40P□DEJ FC6A-C40K□DEJ
USB Type	USB mini-B			
USB Standard	USB 2.0 full speed			
Isolation	Not isolated from the internal circuit			
Communication Function	Maintenance communication to PC			

Note: Specify a terminal type code in place of □ in the Part No. (1: screw fastened type, 4: Push-in type)

Serial Port 1, CAN Port

Part No.	FC6A-C16R□AE FC6A-C16R□CE FC6A-C16P□CE FC6A-C16K□CE FC6A-C16R□DE FC6A-C16P□DE FC6A-C16K□DE	FC6A-C24R□AE FC6A-C24R□CE FC6A-C24P□CE FC6A-C24K□CE	FC6A-C40R□AE FC6A-C40R□CE FC6A-C40P□CE FC6A-C40K□CE FC6A-C40R□DE FC6A-C40P□DE FC6A-C40K□DE	FC6A-C40R□AEJ FC6A-C40R□CEJ FC6A-C40P□CEJ FC6A-C40K□CEJ FC6A-C40R□DEJ FC6A-C40P□DEJ FC6A-C40K□DEJ
Port Type	Serial port 1			CAN port
Communication Type	RS232C or RS485 selectable			CAN
Connector	RJ45			Terminal Block (5-pin)
Cable	CAT. 5 or higher STP			SAE J1939-11/SAE J1939-15
Maximum Baud Rate	115,200 bps			SAE J1939-11: 250 kbps: 40m, stubs, 1m maximum
Maximum Cable Length	RS232C: 5m, RS485: 200m			SAE J1939-15: 250 kbps: 40m, stubs, 3m maximum
Isolation	Not isolated from the internal circuit			Isolated from the internal circuit
Communication Function	Maintenance communication, user communication, Modbus RTU (master/slave)			J1939

Note: Specify a terminal type code in place of □ in the Part No. (1: screw fastened type, 4: Push-in type)

Ethernet Port 1

Part No.	FC6A-C16R□AE FC6A-C16R□CE FC6A-C16P□CE FC6A-C16K□CE FC6A-C16R□DE FC6A-C16P□DE FC6A-C16K□DE	FC6A-C24R□AE FC6A-C24R□CE FC6A-C24P□CE FC6A-C24K□CE	FC6A-C40R□AE FC6A-C40R□CE FC6A-C40P□CE FC6A-C40K□CE FC6A-C40R□DE FC6A-C40P□DE FC6A-C40K□DE	FC6A-C40R□AEJ FC6A-C40R□CEJ FC6A-C40P□CEJ FC6A-C40K□CEJ FC6A-C40R□DEJ FC6A-C40P□DEJ FC6A-C40K□DEJ
Communication Type	IEEE802.3 compliant			
Data Transfer	10BASE-T, 100BASE-TX			
Connector	RJ45			
Cable	CAT. 5 or higher STP			
Maximum Cable Length	100m			
Isolation	Pulse transformer isolation			
Communication Function	Maintenance communication server, User communication (server/client), Modbus TCP (server/client), PING, SNMP			

Note: Specify a terminal type code in place of □ in the Part No. (1: screw fastened type, 4: Push-in type)

CAN J1939

Part No.	FC6A-C40P□CEJ FC6A-C40P□DEJ	FC6A-C40K□CEJ FC6A-C40K□DEJ	FC6A-C40R□AEJ FC6A-C40R□DEJ	FC6A-C40R□CEJ
Supported SAE J1939	SAE J1939-11: Physical Layer, 250K bits/s, Twisted Shielded Pair SAE J1939-15: Reduced Physical Layer, 250K bits/s, Unshielded Twisted Pair SAE J1939-21: Data Link Layer		SAE J1939-71: Vehicle Application Layer SAE J1939-73: Application Layer - Diagnostics SAE J1939-75: Application Layer - Generator Sets and Industrial SAE J1939-81: Network Management	
Transmit/Receive Message	Maximum No. of Send Message		100	
	Maximum No. of Receive Message		200	
	Transmittable PGN		Optional	
	Maximum Length of Transmit/Receive Message		1 to 252 bytes/message	
Transmission Function	Transmission Type		Event transmission/periodical transmission	
	Event Transmission	Transmission Method		Internal relay
		Transmission Method		Internal relay
Cycle Transmission	Transmission Cycle (*1)		10 to 655,350 ms (in increments of 10ms)	
Receive Function	Receive Method		Polling reception (*2)	
	Receive Cycle Monitor		0, 10 to 655,350 ms (disabled at 0)	
Request Function	Yes			
Network Management Function	Static address/dynamic address management			
	NAME	Optional (automatic switching of static address /dynamic address management at highest-order bit)		
	Number of Nodes Manageable	128 nodes		
PGNs used Internally	00EA00h: Request PGN			
	00E800h: Acknowledgement			
	00EB00h: TP.DT			
	00EC00h: TP.CM			
	00EE00h: Address claim			

Note: Specify a terminal type code in place of □ in the Part No. (1: screw fastened type, 4: Push-in type)

*1) Message is transmitted in END processing. Actual transmission cycle is affected by the ladder execution cycle.

*2) Receive message is transferred from internal buffer to data register in END processing.

All-in-One / CAN J1939 All-in-One CPU Modules

Lineup

Plus

All-in-One

Modules

Cartridges

Dimensions

Mounting Hole Layout

Instructions

Input

Part No.	FC6A-C16R□AE FC6A-C16R□CE FC6A-C16P□CE FC6A-C16K□CE FC6A-C16R□DE FC6A-C16P□DE FC6A-C16K□DE	FC6A-C24R□AE FC6A-C24R□CE FC6A-C24P□CE FC6A-C24K□CE	FC6A-C40R□AE FC6A-C40R□CE FC6A-C40P□CE FC6A-C40K□CE FC6A-C40R□DE FC6A-C40P□DE FC6A-C40K□DE	FC6A-C40R□AEJ FC6A-C40R□CEJ FC6A-C40P□CEJ FC6A-C40K□CEJ FC6A-C40R□DEJ FC6A-C40P□DEJ FC6A-C40K□DEJ
Input Points	9 (9/1 common)	14 (14/1 common)	24 (24/1 common)	
Rated Input Voltage (*1)	AC, 24V DC power supply type: 24V DC sink/source input signal 12V DC power supply type: 12V DC sink/source input signal			
Input Voltage Range (*1)	AC, 24V DC power supply type: 0 to 28.8V DC 12V DC power supply type: 0 to 18.0V DC			
Rated Input Current (*1)	AC, 24V DC power supply type: high speed input port 5mA/pt, middle/normal speed input port 7mA/pt 12V DC power supply type: high speed input port 5mA/pt, middle/normal speed input port 6mA/pt			
Input Impedance (*1)	AC, 24V DC power supply type: high speed input port 4.9kΩ, middle/normal speed input port: 3.4kΩ 12V DC power supply type: high speed input port 1.8kΩ, middle/normal speed input port: 2.0kΩ			
Input Delay	Turn ON Time	High speed input port: 5μs + filter value Middle speed input port: 35μs + filter value Normal speed input port: 35μs + filter value		
	Turn OFF Time	High speed input port: 5μs + filter value Middle speed input port: 35μs + filter value Normal speed input port: 100μs + filter value		
Isolation	Between input terminals: Not isolated Internal circuit: Optocoupler-isolated			
Input Type	Type1 (IEC 61131-2)			
External Load for I/O Interconnection	Not needed			
Signal Determination Method	Static			
Effect of Improper Input Connection	Both sinking and sourcing input signals can be connected, therefore reverse connection does not cause damage. If any input exceeding the rated value is applied, permanent damage may be caused.			
Cable Length	3m in compliance with electromagnetic immunity			
Connector	Insertion Durability	100 times		

Note: Specify a terminal type code in place of □ in the Part No. (1: screw fastened type, 4: Push-in type)

*1) 24V DC is for FC6A-C***□CE and FC6A-C40*□CEJ. 12V DC is for FC6A-C***□DE and FC6A-C40*□DEJ.

Transistor Output

Part No.	FC6A-C16P□CE FC6A-C16K□CE FC6A-C16P□DE FC6A-C16K□DE	FC6A-C24P□CE FC6A-C24K□CE	FC6A-C40P□CE FC6A-C40K□CE FC6A-C40P□DE FC6A-C40K□DE	FC6A-C40P□CEJ FC6A-C40K□CEJ FC6A-C40P□DEJ FC6A-C40K□DEJ
Transistor Output Points	7 (7/1 common)	10 (10/1 common)	16 (8/1 common)	
Output Type	Transistor Sink	FC6A-C16K□CE / FC6A-C16K□DE / FC6A-C24K□CE / FC6A-C40K□CE / FC6A-C40K□DE / FC6A-C40K□CEJ / FC6A-C40K□DEJ		
	Transistor Source	FC6A-C16P□CE / FC6A-C16P□DE / FC6A-C24P□CE / FC6A-C40P□CE / FC6A-C40P□DE / FC6A-C40P□CEJ / FC6A-C40P□DEJ		
Rated Load Voltage (*1)	24V DC power supply type: 24V DC 12V DC power supply type: 12V DC			
Voltage Tolerance (*1)	24V DC power supply type: 19.2 to 28.8V DC 12V DC power supply type: 10.2 to 18.0V DC			24V DC: 19.2 to 28.8V DC 12V DC: 10.2 to 16.0V DC
Rated Load Current	Per Point	0.5A		
	Per Common	3.5A	5A	4A
Output Delay	Turn ON Time	High speed input port: 5μs Middle speed input port: 30μs Normal speed input port: 300μs		High speed input port: 5μs Normal speed input port: 300μs
	Turn OFF Time	High speed input port: 5μs Middle speed input port: 30μs Normal speed input port: 300μs		High speed input port: 5μs Normal speed input port: 300μs
Isolation	Between output terminal and Internal circuit: Optocoupler-isolated Between output terminals: Not isolated			
Voltage Drop (ON Voltage)	1V max (voltage between COM and output terminal when output is on.)			
Inrush Current	1A			
Leakage Current	0.1mA maximum			
Clamping Voltage (*1)	24V DC power supply type: 39V ±1V 12V DC power supply type: 39V ±1V			24V DC: 39V ±1V 12V DC: 27V ±1V
Maximum Lamp Load	12W			
Inductive Load (*1)	24V DC power supply type: L/R=10ms (28.8V DC, 1Hz) 12V DC power supply type: FC6A-C16P□DE / FC6A-C16K□DE / FC6A-C40P□DE / FC6A-C40K□DE, L/R=10ms (18.0V DC 1Hz), FC6A-C40P□DEJ / FC6A-C40K□DEJ, L/R=10ms (16.0V DC, 1Hz)			
Overcurrent Protection	Transistor Sink Output: No Transistor Source Output: Overcurrent is detected by current limit resistance. (*2)			
External Current Draw (*1)	24V DC power supply type: 100mA maximum, 24V DC (power voltage at the +V terminal, -V terminal at source) 12V DC power supply type: 100mA maximum, 12V DC (power voltage at the +V terminal, -V terminal at source)			
Connector	Insertion Durability	100 times		

Note: Specify a terminal type code in place of □ in the Part No. (1: screw fastened type, 4: Push-in type)

*1) 24V DC is for FC6A-C***□CE and FC6A-C40*□CEJ. 12V DC is for FC6A-C***□DE and FC6A-C40*□DEJ.

*2) This overcurrent signals consist of one signal per 4 point outputs. When microprocessor gets this overcurrent signal by interrupt input, microprocessor turns off 4pt outputs of this category at fixed time (approx. 1sec).

Lineup Plus CPU Modules / All-in-One / CAN J1939 All-in-One CPU Modules

Relay Output Specifications

Part No.		FC6A-C16R□AE FC6A-C16R□CE FC6A-C16R□DE	FC6A-C24R□AE FC6A-C24R□CE	FC6A-C40R□AE FC6A-C40R□CE FC6A-C40R□DE	FC6A-C40R□AEJ FC6A-C40R□CEJ FC6A-C40R□DEJ
Relay Output Points		7	10	16	
Output Points per Common Line	COM1	4	4	4	
	COM2	3	4	4	
	COM3	—	2	4	
	COM4	—	—	4	
Output Type		1NO			
Maximum Load Current	Per Point	2A			
	Per Common	COM1: 7A COM2: 6A	COM1: 7A COM2: 7A COM3: 4A	COM1: 7A COM2: 7A COM3: 7A COM4: 7A	
Minimum Switching Load		1mA/5V DC (reference value)			
Initial Contact Resistance		30 mΩ maximum			
Electrical Life		100,000 operations minimum (rated resistive load 1,800 operations/hour)			
Mechanical Life		20,000,000 operations minimum (no load 18,000 operations/hour)			
Rated Load		Resistive load: 240V AC 2A, 30V DC 2A Inductive load: 240V AC 2A (cos φ = 0.4), 30V DC 2A (L/R = 7 ms)			
Dielectric Strength		Between output and ground terminals: 2,300V AC, 1 minute Between output terminal and internal circuit: 2,300V AC, 1 minute Between output terminals (COMs): 2,300V AC, 1 minute			
Connector	Insertion/ Removal Durability	100 times			

Note: Specify a terminal type code in place of □ in the Part No. (1: screw fastened type, 3: MIL connector type, 4: Push-in type)

Plus CPU Modules / All-in-One / CAN J1939 All-in-One CPU Modules

Lineup

Plus

All-in-One

Modules

Cartridges

Dimensions

Mounting Hole Layout

Instructions

Temperature derating curves: Input voltage vs. I/O Simultaneous ON Ratio (%)

Plus CPU Module

Input

- FC6A-D16P□CEE
- FC6A-D16K□CEE
- FC6A-D32P□CEE
- FC6A-D32K□CEE

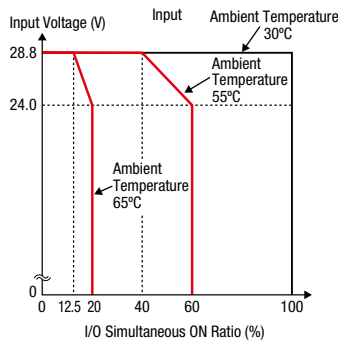

Output

- FC6A-D16P□CEE
- FC6A-D16K□CEE
- FC6A-D32P□CEE
- FC6A-D32K□CEE

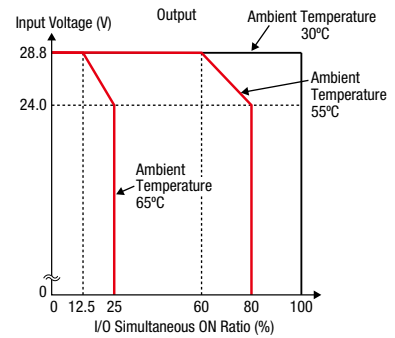

Input

- FC6A-D16R□CEE

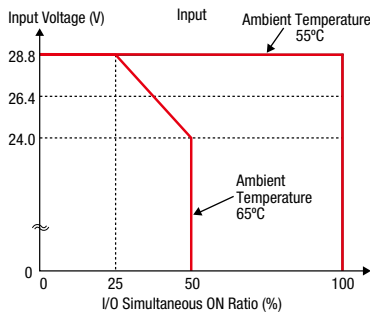

Output

- FC6A-D16R□CEE

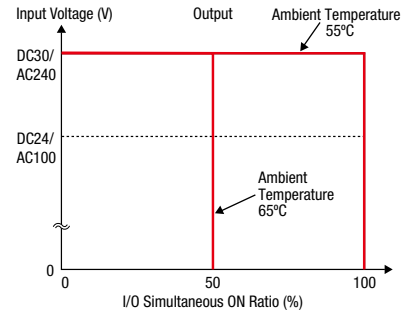

All-in-One / CAN J1939 All-in-One CPU Module (without cartridge)

Input

- FC6A-C16R□AE
- FC6A-C16R□CE
- FC6A-C24R□AE
- FC6A-C24R□CE
- FC6A-C40R□AE
- FC6A-C40R□CE
- FC6A-C40R□AEJ
- FC6A-C40R□CEJ

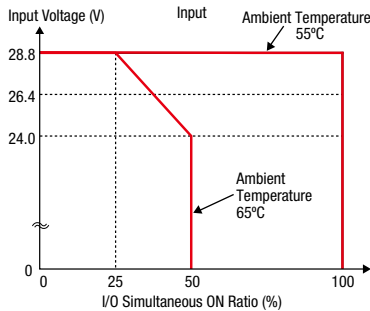

Output

- FC6A-C16R□AE
- FC6A-C16R□CE
- FC6A-C24R□AE
- FC6A-C24R□CE
- FC6A-C40R□AE
- FC6A-C40R□CE
- FC6A-C40R□AEJ
- FC6A-C40R□CEJ

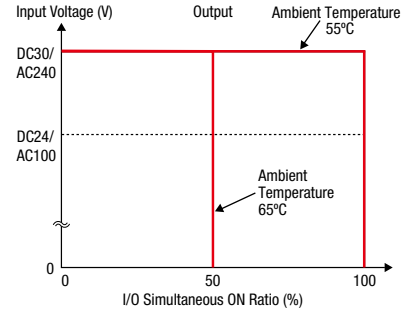

Input

- FC6A-C16R□DE
- FC6A-C40R□DE
- FC6A-C40R□DEJ

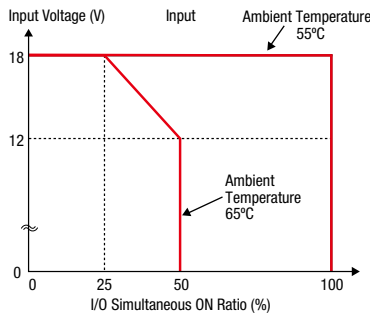

Output

- FC6A-C16R□DE
- FC6A-C40R□DE
- FC6A-C40R□DEJ

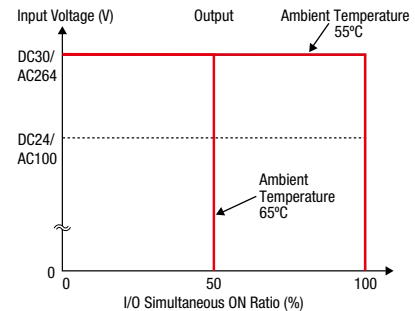

Input

- FC6A-C16P□DE
- FC6A-C24P□CE
- FC6A-C40P□CE
- FC6A-C40P□DE
- FC6A-C40P□CEJ
- FC6A-C40P□DEJ

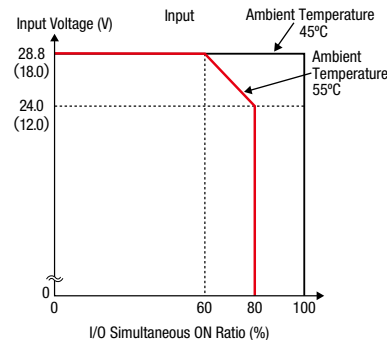

Output

- FC6A-C16P□DE
- FC6A-C24P□CE
- FC6A-C40P□CE
- FC6A-C40P□DE
- FC6A-C40P□CEJ
- FC6A-C40P□DEJ

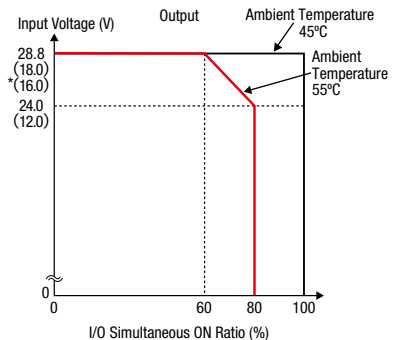

Note: Specify a terminal type code in place of □ in the Part No. (1: screw fastened type, 3: MIL connector type, 4: Push-in type)

• Values in () are for 12V DC model.

• Values shown in * () are for CAN J1939 All-in-One CPU module.

Lineup All-in-One / CAN J1939 All-in-One CPU Modules

All-in-One / CAN J1939 All-in-One CPU Module (with cartridge or when used under ambient temperature exceeding 55°C)

Input

- FC6A-C16P□DE FC6A-C40P□CEJ
- FC6A-C24P□CE FC6A-C40P□DEJ
- FC6A-C40P□CE
- FC6A-C40P□DE

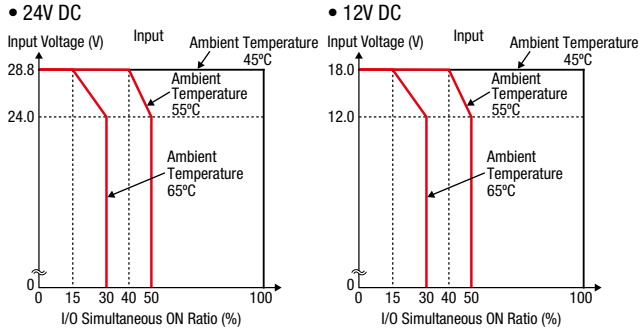

Output

- FC6A-C16P□DE FC6A-C40P□CEJ
- FC6A-C24P□CE FC6A-C40P□DEJ
- FC6A-C40P□CE
- FC6A-C40P□DE

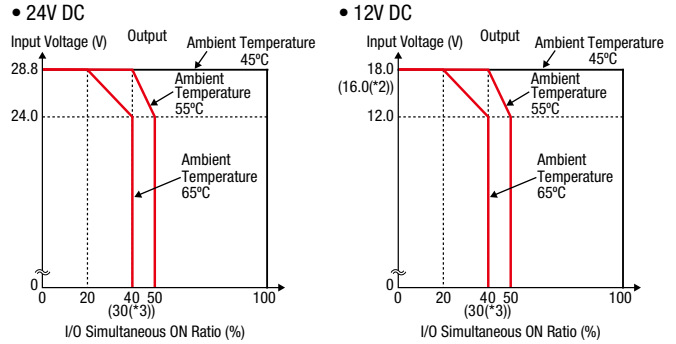

Input

- FC6A-C16K□CE FC6A-C40K□DE
- FC6A-C16K□DE FC6A-C40K□CEJ
- FC6A-C24K□CE FC6A-C40K□DEJ
- FC6A-C40K□CE

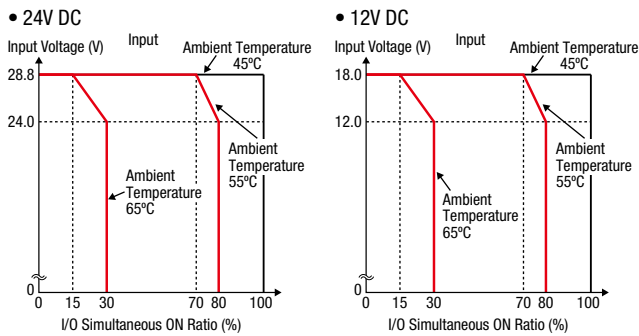

Output

- FC6A-C16K□CE FC6A-C40K□DE
- FC6A-C16K□DE FC6A-C40K□CEJ
- FC6A-C24K□CE FC6A-C40K□DEJ
- FC6A-C40K□CE

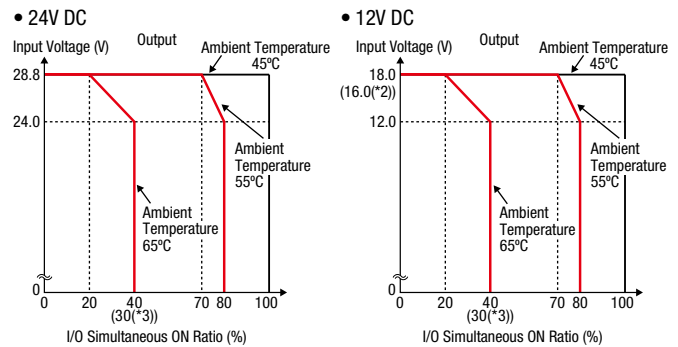

Note: Specify a terminal type code in place of □ in the Part No. (1: screw fastened type, 4: Push-in type)
 *1) Cartridges cannot be used under the expanded ambient operating temperature (-25 to -10°C, +55 to +65°C).
 *2) Values shown in () are for CAN J1939 All-in-One CPU module.
 *3) Values shown in () are for 16 I/O type All-in-One CPU module.

Input Internal Circuit

100V to 240V AC, 24V DC, 12V DC

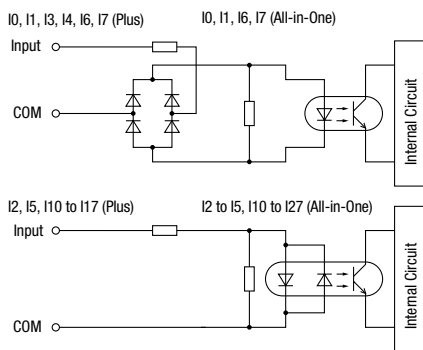

Output Internal Circuit

Transistor Sink Output

24V DC, 12V DC

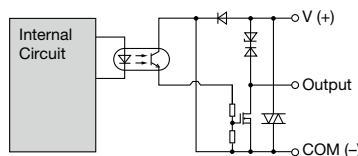

Transistor Source Output

24V DC, 12V DC

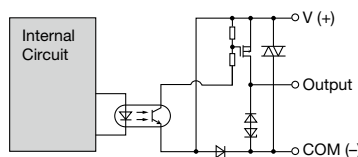

Digital I/O Modules

Lineup

Plus

All-in-One

Modules

Cartridges

Dimensions

Mounting Hole Layout

Instructions

Specifications

Digital Input Module

Part No.	FC6A-N08B□	FC6A-N16B□	FC6A-N16B3	FC6A-N32B3	FC6A-N08A1□	
Input Points	8 (8/1 common)	16 (16/1 common)		32 (16/1 common)	8 (4/1 common)	
Rated Input Voltage	12/24V DC sink/source input signal (24V DC for products lower than V400)				100 to 120V AC	
Input Voltage Range	0 to 28.8V DC				0 to 132V AC (50/60 Hz)	
Rated Input Current	7 mA/point (24V DC), 3.5 mA/point (12V DC)		5 mA/point (24V DC), 2.5 mA/point (12V DC)		17 mA/point (120V AC, 60 Hz)	
Input Impedance	3.4 kΩ		4.4 kΩ		0.8 kΩ (60 Hz)	
OFF Voltage	5V maximum				20V maximum	
ON Voltage	10.2V minimum (15V for products lower than V400)				79V minimum	
OFF Current	1.2 mA maximum		0.9 mA maximum		—	
ON Current	2.8 mA minimum (4.2 mA minimum for products lower than V400)		2.2 mA minimum (3.2 mA minimum for products lower than V400)		—	
Input Delay Time (24V DC)	Turn ON: 4.1ms, Turn OFF: 4.1ms				Turn ON: 25ms, Turn OFF: 30ms	
Isolation	Between input terminals: Not isolated Internal circuit: Optocoupler-isolated				Between input terminals in the same common: Not isolated Between input terminals in different commons: Isolated Between input terminals and internal circuits: Optocoupler-isolated	
External Load for I/O Interconnection	Not needed					
Signal Determination Method	Static					
Effect of Improper Input Connection	Both sink and source input signals can be connected. If any input exceeding the rated value is applied, permanent damage may be caused.				If any input exceeding the rated value is applied, permanent damage may be caused.	
Cable Length	3m in compliance with electromagnetic immunity				—	
Internal Current Draw	All Inputs ON	30mA (5V DC) 0mA (24V DC)	40mA (5V DC) 0mA (24V DC)	40mA (5V DC) 0mA (24V DC)	65mA (5V DC) 0mA (24V DC)	40mA (5V DC) 0mA (24V DC)
	All Inputs OFF	17mA (5V DC) 0mA (24V DC)	17mA (5V DC) 0mA (24V DC)	17mA (5V DC) 0mA (24V DC)	17mA (5V DC) 0mA (24V DC)	17mA (5V DC) 0mA (24V DC)
Internal Power Consumption (at 24V DC while all inputs ON)	0.20W	0.27W	0.27W	0.44W	0.27W	
Connector	Connector Insertion/Removal Durability: 100 times					
Weight (approx.)	FC6A-N08B1: 110g FC6A-N08B4: 95g	FC6A-N16B1: 105g FC6A-N16B4: 95g	75g	110g	FC6A-N08A11: 110g FC6A-N08A14: 95g	

Note: Specify a terminal type code in place of □ in the Part No. (1: screw fastened type, 4: Push-in type)

Note: For operating conditions, see page 9.

Lineup Digital I/O Modules

Plus Relay Output Module

Part No.		FC6A-R08□	FC6A-R16□
Output Points		8 (4/1 common)	16 (8/1 common)
Output Type		1NO	
Maximum Load Current		2A per point	
		7A per common	8A per common
Minimum Switching Load		1 mA/ 5V DC (reference value)	
Initial Contact Resistance		30 mΩ maximum	
Electrical Life		100,000 operations minimum (rated resistive load 1,800 operations/hour)	
Mechanical Life		20,000,000 operations minimum (no load 18,000 operations/hour)	
Rated Load		Resistive load: 240V AC 2A, 30V DC 2A Inductive load: 240V AC 2A (cos φ = 0.4) 30V DC 2A (L/R = 7 ms)	
Dielectric Strength		Between output and ground terminals: 2,300V AC, 1 minute	
		Between output terminal and internal circuit: 2,300V AC, 1 minute	
		Between output terminals (COMs): 2,300V AC, 1 minute	
Internal Current Draw	All outputs ON	35mA (5V DC) 50mA (24V DC)	50mA (5V DC) 100mA (24V DC)
	All outputs OFF	17mA (5V DC) 0mA (24V DC)	17mA (5V DC) 0mA (24V DC)
Internal Power Consumption (at 24V DC while all outputs ON)		1.44W	2.74W
Connector	Insertion/Removal Durability	100 times	
Weight (approx.)		FC6A-R081: 130g FC6A-R084: 115g	FC6A-R161: 140g FC6A-R164: 130g

Note: Specify a terminal type code in place of □ in the Part No. (1: screw fastened type, 4: Push-in type)
 Note: For operating conditions, see page 9.

Transistor Output Module

Part No.		FC6A-T08K□	FC6A-T08P□	FC6A-T16K□	FC6A-T16P□	FC6A-T16K3	FC6A-T16P3	FC6A-T32K3	FC6A-T32P3	
Output Points		8 (8/1 common)				16 (16/1 common)				
Output Type		FC6A-T□K□: Transistor sink output FC6A-T□P□: Transistor source output								
Rated Load Voltage		12/24V DC	24V	12/24V DC	24V	12/24V DC	24V	12/24V DC	24V	
Operating Load Voltage Range		10.2 to 28.8V DC	20.4 to 28.8V DC	10.2 to 28.8V DC	20.4 to 28.8V DC	10.2 to 28.8V DC	20.4 to 28.8V DC	10.2 to 28.8V DC	20.4 to 28.8V DC	
Maximum Load Current		0.5A per point				0.1A per point				
		3A per common				1A per common				
Output Delay	Turn ON Time	400 μs maximum								
	Turn OFF Time	450 μs maximum								
Isolation		Between output terminal and internal circuit: Optocoupler-isolated Between output terminals: Not isolated								
Voltage Drop (ON Voltage)		1V maximum (voltage between COM and output terminals when output is on)								
Inrush Current		1A maximum								
Leakage Current		0.1mA maximum								
Clamping Voltage		Approx. 50V								
Maximum Lamp Load		12W					2.4W			
Inductive Load		L/R = 10ms (28.8V DC 1Hz)								
External Current Draw		FC6A-T□K□: 100 mA maximum, 12/24V DC (power voltage at the +V terminal) FC6A-T□P□: 100 mA maximum, 24V DC (power voltage at the -V terminal)								
Overcurrent Protection		Transistor Sink Output: No Transistor Source Output: Yes								
Internal Current Draw	All outputs ON	25mA (5V DC) 15mA (24V DC)		30mA (5V DC) 25mA (24V DC)		45mA (5V DC) 50mA (24V DC)				
	All outputs OFF	17mA (5V DC) 0mA (24V DC)		17mA (5V DC) 0mA (24V DC)		17mA (5V DC) 0mA (24V DC)				
Internal Power Consumption (at 24V DC while all outputs ON)		0.53W		0.80W		1.50W				
Connector	Insertion/Removal Durability	100 times								
Weight (approx.)		FC6A-T08K1/ FC6A-T08P1: 110g		FC6A-T16K1/ FC6A-T16P1: 105g		75g		115g		
		FC6A-T08K4/ FC6A-T08P4: 95g		FC6A-T16K4/ FC6A-T16P4: 95g						

Note: Specify a terminal type code in place of □ in the Part No. (1: screw fastened type, 4: Push-in type)
 Note: For operating conditions, see page 9.

Digital I/O Modules

Digital Mixed I/O Module

Part No.		FC6A-M08BR□	FC6A-M24BR□	
Input Specifications	Input Points	4 (4/1 common)	16 (16/1 common)	
	Rated Input Voltage	12/24V DC sink/source input signal (24V DC for products lower than V400)		
	Input Voltage Range	0 to 28.8V DC		
	Rated Input Current	7 mA/point (24V DC) 3.5 mA/point (12V DC)		
	Input Impedance	3.4 kΩ		
	OFF Voltage	5V maximum		
	ON Voltage	10.2V minimum (15V minimum for products lower than V400)		
	OFF Current	1.2 mA maximum		
	ON Current	2.8 mA minimum (4.2 mA minimum for products lower than V400)		
	Input Delay Time (24V DC)	Turn ON Time	4.1ms	
		Turn OFF Time	4.1ms	
	Isolation	Between input terminals: Not isolated Internal circuit: Optocoupler-isolated		
	External Load for I/O Interconnection	Not needed		
	Signal Determination Method	Static		
Effect of Improper Input Connection	Both sinking and sourcing input signals can be connected. If any input exceeding the rated value is applied, permanent damage may be caused.			
Cable Length	3m in compliance with electromagnetic immunity			
Output Specifications	Output Points	4 (4/1 common)	8 (4/1 common)	
	Output Type	1NO		
	Maximum Load Current	2A per point 7A per common		
	Minimum Switching Load	1 mA/ 5V DC (reference value)		
	Initial Contact Resistance	30 mΩ maximum		
	Electrical Life	100,000 operations minimum (rated resistive load 1,800 operations/hour)		
	Mechanical Life	20,000,000 operations minimum (no load 18,000 operations/hour)		
	Rated Load	Resistive load: 240V AC 2A, 30V DC 2A Inductive load: 240V AC 2A (cos φ = 0.4), 30V DC 2A (L/R = 7 ms)		
	Dielectric Strength	Between output and ground terminals: 2,300V AC, 1 minute		
		Between output terminal and internal circuit: 2,300V AC, 1 minute		
		Between output terminals (COMs): 2,300V AC, 1 minute		
	Internal Current Draw	All I/Os ON	30mA (5V DC), 25mA (24V DC)	55mA (5V DC), 25mA (24V DC)
		All I/Os OFF	17mA (5V DC), 0mA (24V DC)	17mA (5V DC), 0mA (24V DC)
	Internal Power Consumption (at 24V DC while all I/Os are ON)	0.80W		0.97W
Connector	Insertion/Removal Durability	100 times		
Weight (approx.)	FC6A-M08BR1: 120g FC6A-M08BR4: 100g		FC6A-M24BR1: 165g FC6A-M24BR4: 155g	

Note: Specify a terminal type code in place of □ in the Part No. (1: screw fastened type, 4: Push-in type)

Note: For operating conditions, see page 9.

Temperature derating curves:
Input voltage vs.
I/O Simultaneous ON Ratio (%)

FC6A-N08B□

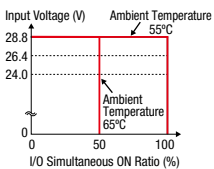

FC6A-N16B□

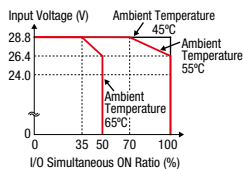

FC6A-N16B3 / FC6A-N32B3

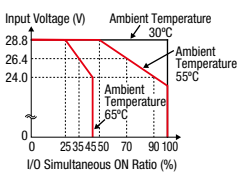

FC6A-N08A1□

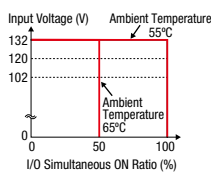

FC6A-M08BR□

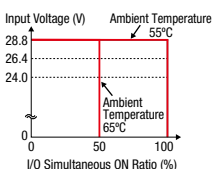

FC6A-M24BR□

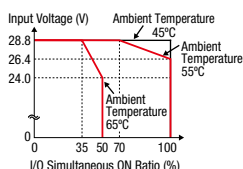

Input Internal Circuit

FC6A-N08B□ / FC6A-N16B□

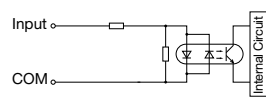

FC6A-N16B3 / FC6A-N32B3

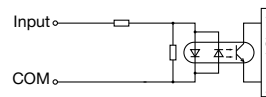

FC6A-M08BR□ / FC6A-M24BR□

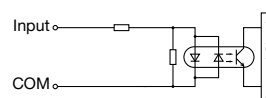

FC6A-N08A1□

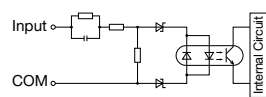

Output Internal Circuit

FC6A-T08K□
FC6A-T16K□
FC6A-T32K3

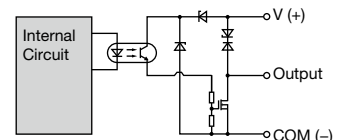

FC6A-T08P□
FC6A-T16P□
FC6A-T32P3

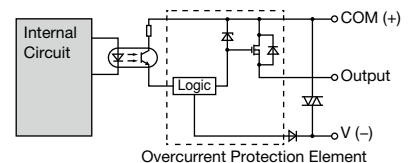

Note: Specify a terminal type code in place of □ in the Part No. (1: screw fastened type, 3: MIL connector type, 4: Push-in type)
Note: See page 4 for part numbers.

Lineup **Analog I/O Modules**

Plus
All-in-One
Analog Module Specifications

Modules	Part No.	FC6A-J2C□	FC6A-J4A□	FC6A-J8A□	FC6A-L06A□ (*2)	FC6A-L03CN□ (*3)	FC6A-J4CN□	FC6A-J4CH□/Y	FC6A-J8CU□	FC6A-K4A□ (*2)	FC6A-K2A□
Cartridges	Input Points	2	4	8	4	2	4	4	8	-	-
Dimensions	Input Signal Type	Voltage (0 to 10V) Voltage (-10 to +10V) Current (0 to 20mA) Current (4 to 20mA)				Voltage (0 to 10V) Voltage (-10 to +10V) Current (0 to 20mA) Current (4 to 20mA) Thermocouple Resistance Thermometer		Thermocouple	Thermocouple Thermistor (NTC, PTC)	-	-
Mounting Hole Layout	Output Points	-	-	-	2	1	-	-	-	4	2
Instructions	Output Signal Style	-	-	-	Voltage (0 to 10V) Voltage (-10 to +10V) Current (0 to 20mA) Current (4 to 20mA)	-	-	-	-	Voltage (0 to 10V) Voltage (-10 to +10V) Current (0 to 20mA) Current (4 to 20mA)	-
	External Power Supply	Rated Power Voltage 12/24V DC, Allowable Voltage Range 10.2 to 28.8V DC28.8V (However, FC6A-L06A□ and K4A are DC24V, DC20.4 to 28.8V)									
	External Current Draw (*1)	50mA (DC12V) 25mA (DC24V)	60mA (DC12V) 30mA (DC24V)	80mA (DC12V) 40mA (DC24V)	100mA (DC24V)	160mA (DC12V) 80mA (DC24V)	80mA (DC12V) 40mA (DC24V)	80mA (DC12V) 40mA (DC24V)	60mA (DC12V) 30mA (DC24V)	125mA (DC24V)	140mA (DC12V) 70mA (DC24V)
	Internal Power Consumption (5V DC)	40mA max.	45mA max.	40mA max.	55mA max.	55mA max.	50mA max.	50mA max.	45mA max.	50mA max.	40 mA max.
	Internal Power Consumption (at 24V DC while all I/Os are ON)	0.27W	0.30W	0.27W	0.37W	0.37W	0.34W	0.34W	0.30W	0.34W	0.27W
	Connector Insertion/Removal Durability	100 times minimum									
	Weight (approx.)	FC6A-J2C1: 115g FC6A-J2C4: 100g	FC6A-J4A1: 110g FC6A-J4A4: 100g	FC6A-J8A1: 110g FC6A-J8A4: 100g	FC6A-L06A1: 110g FC6A-L06A4: 100g	FC6A-L03CN1: 115g FC6A-L03CN4: 100g	FC6A-J4CN1: 110g FC6A-J4CN4: 100g	FC6A-J4CH1Y: 110g FC6A-J4CH4Y: 100g	FC6A-J8CU1: 110g FC6A-J8CU4: 100g	FC6A-K4A1: 115g FC6A-K4A4: 100g	FC6A-K2A1: 115g FC6A-K2A4: 100g

Note: Specify a terminal type code in place of □ in the Part No. (1: screw fastened type, 4: Push-in type)
 *1) The external current draw is the value when all the analog inputs are used and the analog output value is at 100%.
 *2) FC6A-K4A□ and -L06A□ cannot be used under the expanded ambient operating temperature (-25 to -10°C, +55 to +65°C).
 *3) Do not use FC6A-L03CN□ analog voltage output in an environment exceeding ambient temperature 55°C.
 Note: For operating conditions, see page 9.

Input Specifications

Part No.	FC6A-J2C□		FC6A-J8A□		FC6A-J4A□ / FC6A-L06A□			
Input Signal Type	Voltage Input	Current Input	Voltage Input	Current Input	Voltage Input	Current Input		
Input Range	0 to 10V -10 to +10V	0 to 20mA 4 to 20mA	0 to 10V -10 to +10V	0 to 20mA 4 to 20mA	0 to 10V -10 to +10V	0 to 20mA 4 to 20mA		
Input Impedance	1MΩ maximum		50Ω maximum		1MΩ maximum			
Input Detection Current	-		-		-			
AD Conversion	Sampling Time	1ms		1ms or 10ms (selectable with WindLDR)		1ms or 10ms (selectable with WindLDR)		
	Sampling Repetition Time	Sampling time × valid input channels						
	Total Input System Transfer Time	Sampling time + sampling repetition time + 1 scan time						
	Type of Input	Single-ended input						
	Operating Mode	Self-scan						
Input Error	Conversion Method	Σ Δ type ADC						
	Maximum Error at 25°C	±0.1% of full scale		±0.2% of full scale		±0.2% of full scale		
	Cold Junction Compensation Error Temperature Coefficient	±0.006% of full scale/°C		±0.01% of full scale/°C		±0.01% of full scale/°C		
Data	Digital Resolution	65,536 increments (16 bits)		65,536 increments (16 bits) (*1)		4,096 increments (12 bits) *FC6A-J8A1: can be expanded to 16-bit input (selectable with WindLDR)		
	Input per Resolution	0 to 10V: 0.15mV -10 to +10V: 0.30mV	0 to 20mA: 0.30μA 4 to 20mA: 0.244μA	0 to 10V: 0.15mV -10 to +10V: 0.30mV	0 to 20mA: 0.30μA 4 to 20mA: 0.244μA	0 to 10V: 2.44mV -10 to +10V: 4.88mV	0 to 20mA: 4.88μA 4 to 20mA: 3.91μA	
	Data Type in Application Program	Optional: -32,768 to 32,767 (selectable for each channel) (*2)						
	Monotonicity	Yes						
Noise Resistance	Input Data Out of Range	Detectable (*3)						
	Input Filter	Soft filter (0 to 10 s, selectable in increments of 0.1 s) (selectable with WindLDR)						
	Recommended Cable for Noise Immunity Crosstalk	Pair shielded cable						
Isolation	Between input and power circuit: Transformer-isolated Between input and internal circuit: Optocoupler-isolated							
Effect of Improper Input Connection	No damage							
Maximum Permanent Allowed Overload (No Damage)	30V DC (*4)		160mA (*5)		30V DC		160mA (*5)	
Selection of Analog Input Signal Type	Selectable with WindLDR							
Calibration or Verification to Maintain Rated Accuracy	Not possible							

Note: Specify a terminal type code in place of □ in the Part No. (1: screw fastened type, 4: Push-in type)
 *1) Binary data (16 bits) and optional range (16 bits) can be used with the following versions.
 FC6A-J8A□: Version 200 or later WindLDR: Version 8.6.0 or later
 If a FC6A-J8A□ that does not correspond to the above version numbers is set to binary data (16 bits) or optional range (16 bits), an error will occur and the module will operate as binary data (12 bits).
 *2) The arbitrary setting is a function that uses the digital resolution data by scaling it to arbitrary data (that arbitrarily sets the lower limit value and the upper limit value). The range setting (-32,768 to 32,767) is specified with data registers.
 *3) Input data out of range is reflected in the status of the analog I/O module.
 *4) FC6A Ver. 200 and later: voltage input 13V DC, current input 40mA DC
 *5) If current of more than 160mA is applied at 25°C, a protect function works to protect the input circuit by reducing current. However, when a current is applied at a voltage of more than 30V DC, the circuit will be damaged.

Analog I/O Modules

Lineup

Plus

All-in-One

Modules

Cartridges

Dimensions

Mounting Hole Layout

Instructions

Input Specifications

Part No.		FC6A-L03CN□ / FC6A-J4CN□			FC6A-J4CH□Y	FC6A-J8CU□				
Input Signal Type		Voltage Input	Current Input	Resistance Thermometer	Thermocouple	Thermocouple	Thermocouple	NTC Thermistor	PTC Thermistor	
Input Range		0 to 10V DC -10 to +10V	0 to 20mA 4 to 20mA	Pt100, Pt1000 3-wire type (-200 to 850°C) Ni100, Ni1000 3-wire type (-60 to 180°C)	Type K (-200 to +1,300°C) Type J (-200 to +1,000°C) Type R (0 to 1,760°C) Type S (0 to 1,760°C) Type B (0 to 1,820°C) Type E (-200 to +800°C) Type T (-200 to +400°C) Type N (-200 to +1,300°C) Type C (0 to 2,315°C)			-90 to +150°C	100 to 10,000Ω	
Input Impedance		1 MΩ minimum	50Ω maximum	1 MΩ minimum	1 MΩ minimum	1 MΩ minimum	1 MΩ minimum	1 MΩ minimum	1 MΩ minimum	
Input Detection Current		—	—	0.1mA maximum	0.1mA maximum	0.1mA maximum	0.1mA maximum	0.1mA maximum	0.1mA maximum	
AD Conversion	Sampling Time	10ms, 100ms (selectable using WindLDR)		104ms	30ms, 120ms (selectable using WindLDR)		104ms			
	Sampling Repetition Time	Sampling time × valid input channels								
	Total Input System Transfer Time	Sampling time + sampling repetition time + 1 scan time								
	Type of Input	Single-ended input				Differential input		Single-ended input		
	Operating Mode	Self-scan								
Conversion Method		Σ Δ type ADC								
Input Error	Maximum Error at 25°C	±0.2% of full scale		FC6A-L03CN□: ±0.1% of full scale + cold junction compensation error FC6A-J4CN□: ±0.2% of full scale + cold junction compensation error (*3)		±0.2% of full scale + cold junction compensation error (*3)		±0.2% of full scale + cold junction compensation error (*3)		
	Cold Junction Compensation Error	—	—	—	±4°C maximum		±4°C maximum		±4°C maximum	
	Temperature Coefficient	FC6A-L03CN□: 0.006%/°C of full scale FC6A-J4CN□: 0.01%/°C of full scale			0.01%/°C of full scale		0.01%/°C of full scale			
Data	Digital Resolution	65,536 increments (16 bits)		Pt100: approx. 10,500 increments (14 bits) Pt1,000: approx. 8,000 increments (13 bits) Ni100: approx. 2,400 increments (12 bits) Ni1,000: approx. 2,400 increments (12 bits)	Type K: approx. 15,000 increments (14 bits) Type J: approx. 12,000 increments (14 bits) Type R: approx. 17,600 increments (15 bits) Type S: approx. 17,600 increments (15 bits) Type B: approx. 18,200 increments (15 bits) Type E: approx. 10,000 increments (14 bits) Type T: approx. 6,000 increments (13 bits) Type N: approx. 15,000 increments (14 bits) Type C: approx. 23,150 increments (15 bits)			NTC: approx. 2,400 increments (12 bits) PTC: approx. 9,900 increments (14 bits)		
	Input Value of LSB	0 to 10V: 0.15mV -10 to +10V: 0.30mV	0 to 20mA: 0.30μA 4 to 20mA: 0.244μA	0.1°C	0.1°C	0.1°C	0.1°C	0.1°C	1Ω	
	Data Type in Application Program	Optional: selectable for each channel from -32,768 to 32,767 (*1)								
	Monotonicity	Yes								
	Input Data Out of Range	Detectable (*2)								
Noise Resistance	Input Filter	Soft filter (0 to 10 s, selectable in increments of 0.1 s) (selectable with WindLDR)								
	Recommended Cable for Noise Immunity	Pair shielded cable			Pair cable					
	Crosstalk	1 LSB maximum								
Isolation	Between input and power circuit	Transformer-isolated								
	Between input and internal circuit	Optocoupler-isolated								
	Between inputs	Not isolated				Optocoupler-isolated		Not isolated		
Effect of Improper Input Connection	No damage									
Maximum Permanent Allowed Overload (No Damage)	30V DC (*4)	160mA (*5)								
Selection of Input Signal Type and Input Range	Selectable with WindLDR									
Calibration or Verification to Maintain Rated Accuracy	Not possible									

Note: Specify a terminal type code in place of □ in the Part No. (1: screw fastened type, 4: Push-in type)

*1) The data processed in the analog I/O module can be linear-converted to a value between -32,768 and 32,767. The optional range designation, and analog I/O data minimum and maximum values can be selected using data registers allocated to analog I/O modules.

*2) When an error is detected, a corresponding error code is stored to a data register allocated to analog I/O operating status.

*3) R, S: ±6 (0 to 200°C)

B: no compensation

K, J, E, T, N: ±0.4% of full scale (0°C maximum)

*4) FC6A Ver. 200 and later: voltage input 13V DC, current input 40mA DC

*5) If current of more than 160mA is applied at 25°C, a protect function works to protect the input circuit by reducing current. However, when a current is applied at a voltage of more than 30V DC, the circuit will be damaged.

Lineup **Analog I/O Modules / PID Modules**

Plus **Analog Modules**

All-in-One **Output Specifications**

Modules	Part No.	FC6A-K2A□ / FC6A-K4A□	FC6A-L06A□	FC6A-L03CN□	
Cartridges	Output Signal Style/Output Range	Voltage	0 to 10V DC -10 to +10VDC		
Dimensions		Current	0 to 20mA 4 to 20mA		
Mounting Hole Layout	Load	Impedance	Voltage output: 1 kΩ minimum Current output: 300Ω maximum		
Instructions		Load Type	Resistive load		
	DA Conversion	DA Conversion Time	1ms		
		Output Update Interval	1ms		
		Total Output System Transfer Time	DA Conversion Time + Output Update Interval + 1 scan time		
	Output Error	Maximum Error at 25°C	±0.2% of full scale	±0.1% of full scale	±0.2% of full scale
		Temperature Coefficient	±0.01%/°C of full scale	±0.006%/°C of full scale	±0.01%/°C of full scale
		Repeatability after Stabilization Time	±0.4% of full scale		
		Output Voltage Drop	No damage		
		Non-linearity	±0.2% of full scale	±0.01%/°C of full scale	±0.2% of full scale
		Output Ripple	20mV maximum		
		Overshoot	0%		
		Total Error	±1% of full scale		
	Data	Digital Resolution	4,096 increments (12 bits)		
		Output Value of LSB	Voltage	0 to 10V DC: 2.44mV -10 to +10V DC: 4.88mV	
			Current	0 to 20mA: 4.88μA 4 to 20mA: 3.91μA	
		Data Type in Application Program	Optional: -32,768 to 32,767 (selected for each channel)		
		Monotonicity	Yes		
		Current Loop Open	Undetectable		
	Noise Resistance	Recommended Cable for Noise Immunity	Pair shielded cable		
		Crosstalk	1LSB		
	Isolation	Between output and power circuit	Transformer-isolated		
		Between output and internal circuit	Optocoupler-isolated		
	Effect of Improper Output Connection	No damage			
	Selection of Analog Output Signal Type	Selectable with WindLDR			
	Calibration or Verification to Maintain Rated Accuracy	Not possible			

Note: Specify a terminal type code in place of □ in the Part No. (1: screw fastened type, 4: Push-in type)
 Note: For operating conditions, see page 9.

Specifications (PID Module)

Input Range

Part No.	FC6A-F2MR□ / FC6A-F2M□		
Input	Input Range (Digital Resolution)		Input Value per Step
K	-200 to 1,370°C	-328 to 2,498°F	1°C (°F)
	-200.0 to 400.0°C	-328.0 to 752.0°F	0.1°C (°F)
J	-200 to 1,000°C	-328 to 1,832°F	1°C (°F)
R	0 to 1,760°C	32 to 3,200°F	1°C (°F)
S	0 to 1,760°C	32 to 3,200°F	1°C (°F)
B	0 to 1,820°C	32 to 3,308°F	1°C (°F)
E	-200 to 800°C	-328 to 1,472°F	1°C (°F)
T	-200.0 to 400.0°C	-328.0 to 752.0°F	0.1°C (°F)
N	-200 to 1,300°C	-328 to 2,372°F	1°C (°F)
PL-II	0 to 1,390°C	32 to 2,534°F	1°C (°F)
C (W/Re5-26)	0 to 2,315°C	32 to 4,199°F	1°C (°F)
Pt100	-200 to 850°C	-328 to 1,562°F	1°C (°F)
	-200.0 to 850.0°C	-328.0 to 1,562.0°F	0.1°C (°F)
JPt100	-200 to 500°C	-328 to 932°F	1°C (°F)
	-200.0 to 500.0°C	-328.0 to 932.0°F	0.1°C (°F)
DC 4 to 20mA	-2,000 to 10,000 (12,000 increments) (*1)		1.333μA
DC 0 to 20mA	-2,000 to 10,000 (12,000 increments) (*1)		1.666μA
DC 0 to 1V	-2,000 to 10,000 (12,000 increments) (*1)		0.083mA
DC 0 to 5V	-2,000 to 10,000 (12,000 increments) (*1)		0.416mA
DC 1 to 5V	-2,000 to 10,000 (12,000 increments) (*1)		0.333mA
DC 0 to 10V	-2,000 to 10,000 (12,000 increments) (*1)		0.833mA

Note: Specify a terminal type code in place of □ in the Part No. (1: screw fastened type, 4: Push-in type)
 *1) Linear-conversion is possible.

PID Modules

Ratings

Part No.		FC6A-F2MR□	FC6A-F2M□
Power Voltage		24V DC (external power), 5V DC (internal power)	
Allowable Voltage Range		20.4 to 28.8V DC	
Maximum Power Consumption		3.6W	
Internal Power Consumption		65mA (5V DC)	
Control Mode	Independent PID Control	Possible	
	Heating/Cooling Control	Possible (overlapping deadband settings available) (*1)	
	Difference Input Temperature Control	Possible (*1)	
	Cascade Control	Possible (*1)	
Input Points		2ch	
Input Type Input Range	Thermocouple	K, J, R, S, B, E, T, N, PL-II, C (W/Re5-26) External resistance: 100Ω maximum	
	Resistance Thermometer	Pt100, JPt100, 3-wire type	
	Current Input	0 to 20 mA DC, 4 to 20 mA DC Input impedance: 50Ω	
	Voltage Input	0 to 1V DC Input impedance: 1MΩ minimum 0 to 5V DC, 1 to 5V DC, 0 to 10V DC Input impedance: 100kΩ minimum	
AD Conversion	Sampling Time	100 ms	
	Sampling Repetition Time	100 ms	
	Total Input System Transfer Time	Sampling time + sampling repetition time + 1 scan time	
	Type of Input	Differential input	
	Conversion Method	Σ Δ type ADC	
Maximum Error at 25°C	Thermocouple Input	±0.2% of full scale or ±2°C (4°F), whichever is greater However, R, S inputs: 0 to 200°C (0 to 400°F): ±6°C (12°F) B input: 0 to 300°C (0 to 600°F) Accuracy is not guaranteed. K, J, E, T, N inputs: Less than 0°C (32°F): ±0.4% of full scale	
	Resistance Thermometer Input	±0.1% of full scale or ±1°C (2°F), whichever is greater	
	Voltage/Current Inputs	±0.2% of full scale	
Cold Junction Temperature Compensation Accuracy		±1°C at 0 to 55°C	
Temperature Coefficient		±0.005%/°C of full scale	
Noise Resistance	Input Filter	Yes	
	Recommended Cable for Noise Immunity	Pair shielded cable (current/voltage)/Pair cable (temperature input)	
	Cross Talk	None	
Isolation	Between input and power circuit	Transformer-isolated	
	Between input and internal circuit	Optocoupler-isolated	
	Between inputs	Optocoupler-isolated	
Output Points		2ch	
Output	Relay output: 1NO Rated load: 5A 250V AC/30V DC (resistive load) 3A 250V AC (inductive load cos φ=0.4) 3A 30V DC (inductive load VR=7ms) Minimum open/closed load: 10 mA 5V DC (reference value) Electrical life: 100,000 cycles (at the maximum rating of resistive load)		Non-contact voltage output (for SSR drive) 12V DC±15% Maximum 40 mA (short circuit protected) Analog current output 4 to 20 mA DC Load resistance: 550Ω maximum Analog output digital resolution: 1,000 (10 bits) LSB input value: 0.016 mA
	Recommended Cable for Noise Immunity	—	Pair shielded cable
Noise Resistance	Cross Talk	—	None
	Between output and power circuit	Transformer-isolated	
Isolation	Between input and internal circuit	Optocoupler-isolated	
Weight (approx.)		FC6A-F2MR1 / FC6A-F2M1: 140g FC6A-F2MR4 / FC6A-F2M4: 130g	

Note: Specify a terminal type code in place of □ in the Part No. (1: screw fastened type, 4: Push-in type)

*1) Dual channel input is required for one loop control.

*2) FC6A-F2MR□ and -F2M□ cannot be used under the expanded ambient operating temperature (-25 to -10°C, +55 to +65°C).

Note: For operating conditions, see page 9.

Lineup

Plus

All-in-One

Modules

Cartridges

Dimensions

Mounting Hole Layout

Instructions

Lineup **Analog I/O Modules / PID Modules**

Plus
All-in-One
Modules
Cartridges
Dimensions
Mounting Hole Layout
Instructions

Input Circuit

FC6A-J2C□ / FC6A-J4A□
FC6A-J8A□ / FC6A-L06A□

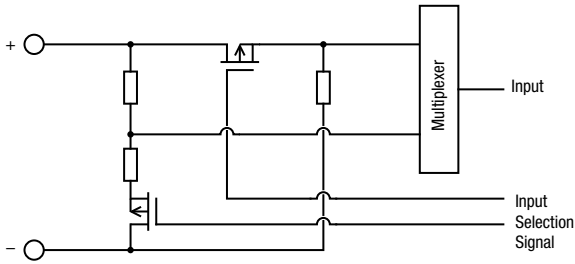

FC6A-J4CN□ / FC6A-L03CN□

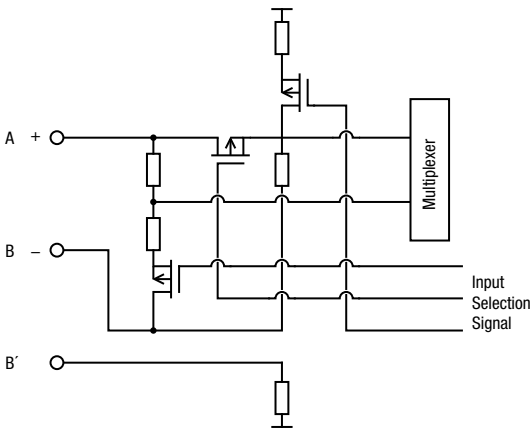

FC6A-J8CU□

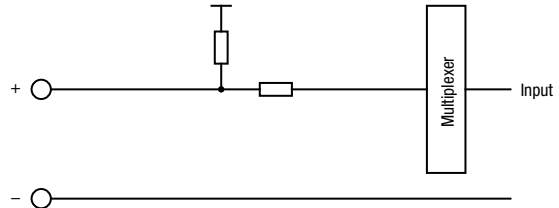

FC6A-F2M□ / FC6A-F2MR□

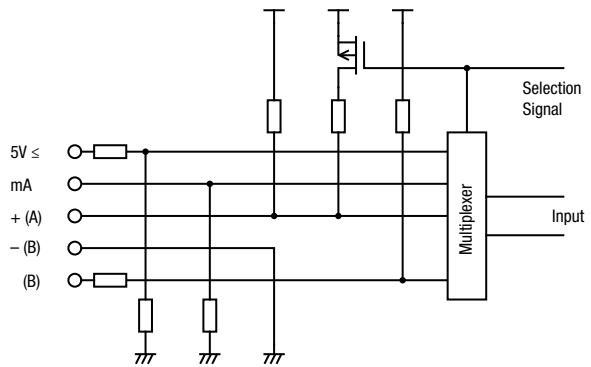

FC6A-J4CH□Y

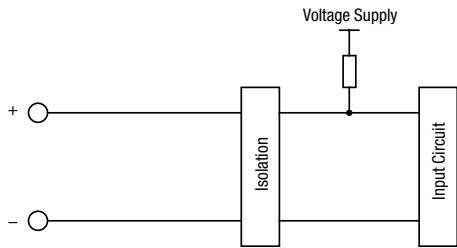

Output Circuit

FC6A-L03CN□ / FC6A-L06A□
FC6A-K2A□ / FC6A-K4A□

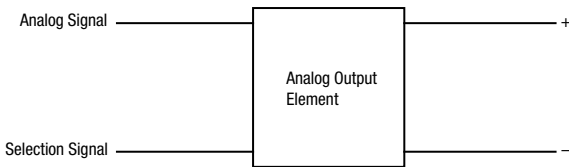

FC6A-F2M□
(Non-contact voltage output for SSR drive)

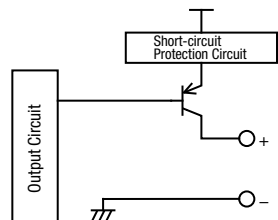

FC6A-F2M□
(current output)

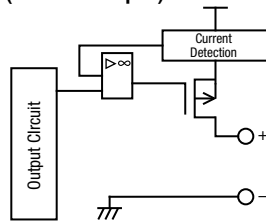

FC6A-F2MR□

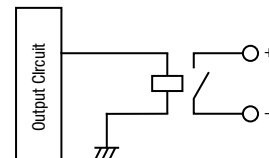

Note: Specify a terminal type code in place of □ in the Part No.
(1: screw fastened type, 4: Push-in type)
Note: See page 6 for part numbers.

HMI Module / Communication Module

Lineup

Plus

All-in-One

Modules

Cartridges

Dimensions

Mounting Hole Layout

Instructions

HMI Module Specifications

General

Part No.	FC6A-PH1
Power Consumption Inside Module (without connection cartridge)	100mA (5V) 15mA (24V)
Cartridge (option)	One analog cartridge can be added Any cartridge can be added when using on Plus CPU module
Weight (approx.)	170g

Operation

Part No.	FC6A-PH1
Operation Method	Rubber Switch
Operating Force	2.0N minimum
Mechanical Life	10,000 operations
Multiple Operation	Possible

Display

Part No.	FC6A-PH1	
Display	STN Monochrome LCD	
Color/Shade	Monochrome	
Effective Display Area	47.98W × 8.22H mm	
Display Resolution	192W × 64H pixels	
View Angle	Right and left 30°, up 20°, down 40°	
Contrast adjustment	Not possible	
Backlight	LED (green)	
Brightness	45 cd/m ²	
Brightness Adjustment	Not possible	
Backlight Control	ON/OFF	
Backlight Replacement	Not possible	
Display Character Size	1/2 size	8 × 16 pixels (JIS 8-bit code, Western European language ISO 8859-1, Cyrillic ANSI1251)
	Full size	16 × 16 pixels (Japanese JIS first level characters, simplified Chinese)
Quantity of Characters	1/2 size	24 characters × 4 lines
	Full size	12 characters × 4 lines
Character Attribute	Blink, reverse	

HMI Ethernet Port

Part No.	FC6A-PH1	
Communication	Complies with IEEE802.3	
Transmission speed	10BASE-T, 100BASE-TX	
Protocol	Datalink layer: IP/ARP Network layer: TCP/UDP, ICMP Application layer: DHCP, DNS, HTTP, SMTP	
Connector	RJ45	
Cable	CAT 5. STP	
Maximum Cable Length	100m	
Isolation from Internal Circuit	Pulse transformer isolation	
Major Functions	Remote Maintenance	Uploading, downloading and monitoring user programs using WindLDR via Ethernet Number of connections: 8
	Web Server	5MB max. total size of system web page and user web page (system web page: about 500KB) Number of connections: 8 maximum Authentic method: digest authentication
	HMI Module System Software V.1.20 and later	
	Send E-mail	Sends preregistered e-mails. Up to 255 types of e-mails can be sent. Authentic method: SMTP-Auth (login), SMTP-Auth (CRAM-MD5), SMTPs Encoding method: BASE64 encode selectable
	E-mail Size	The maximum size of texts for To or Cc is 512 bytes. (*1) E-mail subject: 255 bytes maximum E-mail body: 4,096 bytes maximum Attached CSV file: 4,096 bytes maximum (includes spaces, separator characters, and newlines)

*1) Comma (,) is inserted as a separating character between e-mail addresses.

*2) Operating temperature for FC6A-PH1 is +0 to +55°C.

Cannot be used under the expanded ambient operating temperature (-25 to -10°C, +55 to +65°C).

Communication Module Specifications

General

Part No.	FC6A-SIF52□	
No. of Ports	2	
No. of Connectable CPU	15 max. (when using an unibody expansion interface modules)	
Communication Type	RS232C or RS485 selectable (per port)	
Maximum Baud Rate	115,200 bps	
No. of Slaves	RS485: 31 (per port)	
Maintenance Communication	Possible	
Modbus Communication	Possible	
Datalink	Possible	
Isolation	Between ports: transformer-isolated Between input circuits and communication: transformer- and optocoupler-isolated	
Maximum Cable Length	RS232C: 15m RS485: 1,200m	
Recommended Cable	RS232C: 0.2mm2 shielded 6-core cable RS485: 0.3mm2 shielded twisted pair cable (2P)	
Power Consumption Inside Module (without connection cartridge)	24V DC: 35mA, 5V DC: 35mA	
Connector	Insertion/Removal Durability	100 times
Weight	FC6A-SIF52: 110g FC6A-SIF524: 100g	

Note: Specify a terminal type code in place of □ in the Part No. (blank: screw fastened type, 4: Push-in type)

Note: For operating conditions, see page 9.

Lineup **Expansion Interface Modules / Cartridge Base Modules**

Plus **Specifications**
 All-in-One **Expansion Interface Modules**

Modules **Unibody Type**

Cartridges	Part No.		FC6A-EXM2□
Dimensions	I/O Expansion	Between CPU module and expansion interface module: Connectable I/O modules	7 maximum (224 I/Os maximum)
		Beyond the expansion interface module: Connectable I/O modules	8 maximum (256 I/Os maximum)
Mounting Hole Layout	Rated Power Voltage		24V DC
	Allowable Voltage Range		20.4 to 28.8V DC
Instructions	Power Consumption	Internal power (supplied from CPU module)	20 mA (5V DC), 0 mA (24V DC)
		External power	With I/O modules (*1) 0.75A (26.4V DC)
Maximum Power Consumption (*1) (External Power)		0.5W (24V DC)	
Allowable Momentary Power Interruption		10ms minimum (24V DC)	
Isolation from Internal Circuit		Not isolated	
No. of Connectable CPU		Plus: 11, All-in-one: 1	
Connector	Insertion/Removal Durability		100 times
	Weight (approx.)		150g

Note: Specify a terminal type code in place of □ in the Part No. (blank: screw fastened type, 4: Push-in type)
 *1) Power consumption by the expansion interface module and eight I/O modules.
 Note: For operating conditions, see page 9.

Separate Master Type

Part No.		FC6A-EXM1M
No. of Connectable CPU		Plus: 1
No. of Connectable Slaves		10
Connector		RJ45
Cable		CAT. 5 or higher STP
Maximum Cable Length		100m
Isolation from Internal Circuit		Pulse transformer isolation
Power Consumption inside Module		DC5V: 75mA
Weight (approx.)		80g

Note: When using an expansion interface module (separate master type), the no. of connectable expansion modules to the basic expansion side of Plus CPU module is 5 maximum.
 (13 max. modules when using an expansion interface (unibody type))
 Note: For operating conditions, see page 9.

Separate Slave Type

Part No.		FC6A-EXM1S□
I/O Expansion	Between CPU module and expansion interface module: Connectable I/O modules	7 maximum (224 I/Os maximum)
	Beyond the expansion interface module: Connectable I/O modules	8 maximum (256 I/Os maximum)
Rated Power Voltage		24V DC
Allowable Voltage Range		20.4 to 28.8V DC
Maximum Power Consumption (*1) (External Power)		24.5W
Allowable Momentary Power Interruption		10ms minimum (24V DC)
Connectable Expansion Modules		Digital I/O Module Analog I/O Module
Isolation from Internal Circuit	Between internal circuits and power supply	Not isolated
	Between input circuits and communication	Pulse transformer isolation
Connector	Insertion/Removal Durability	
	100 times	
Communication	Connector	RJ45
	Cable	CAT. 5 or higher STP
	Maximum Cable Length	100m
Weight (approx.)		165g

Note: Specify a terminal type code in place of □ in the Part No. (blank: screw fastened type, 4: Push-in type)
 *1) Power consumption by the expansion interface module and seven I/O modules.
 Note: For operating conditions, see page 9.

Cartridge Base Module

Part No.		FC6A-HPH1
No. of Connectable Cartridges		2
Connectable Cartridges		Communication cartridge, digital I/O cartridge, analog I/O cartridge
No. of Connectable CPU		Plus: 1
Weight (approx.)		95g

Note: Cannot be used under the expanded ambient operating temperature.

Cartridges

Lineup

Plus

All-in-One

Modules

Cartridges

Dimensions

Mounting Hole Layout

Instructions

Communication Cartridge Specifications

Note: Cannot be used under expanded ambient operating temperature.

Serial Communication

Part No.	FC6A-PC1	FC6A-PC3
Standards	EIA RS232C	EIA RS485
Maximum Baud Rate	115,200 bps	
Maintenance Communication	Possible	Possible
User Communication	Possible	Possible
Data Link Communication	Possible	Possible
Modbus RTU	Possible	Possible
Half-duplex Communication	—	Possible
Maximum Cable Length	5m	200m
Quantity of Slave Stations	—	31
Isolation between Internal Circuit and Communication Port	Not isolated	
RS485 Cable	Recommended Cable	0.2mm ² shielded 3-core cable
	Conductor Resistance	0.3mm ² shielded twisted pair cable (2P) 85 Ω/km maximum
	Shield Resistance	20 Ω/km maximum

Bluetooth Communication

Part No.	FC6A-PC4
Bluetooth Standard	Bluetooth ver 2.1 + EDR
Profile	SPP (Serial Port Profile) iAP (iPod Accessory Protocol)
Frequency Range	2,402 MHz to 2,480 MHz
Wireless Transmission Distance *1	10m (Class 2)
Multi-point Function	8 units
Communication Protocol	Maintenance communication protocol User communication protocol
Bluetooth Wireless Approved Regions *2	Japan, People's Republic of China, USA, Canada, Australia, New Zealand, Europe

*1) Connection effective range is affected by obstacles (human, metal, wall) and wave signal condition. Make sure to confirm the connection status before actual operation.

*2) Depending on countries or regions, evaluation on the device equipped with FC6A may be necessary.

Note: Communication performance (required time) in maintenance communication is as follows.
 User program upload equivalent to 10,000 steps: 40 seconds approx.
 User program download equivalent to 10,000 steps: 50 seconds approx.
 User program upload equivalent to 20,000 steps: 1 minute 20 seconds approx.
 User program download equivalent to 20,000 steps: 1 minute 40 seconds approx.
 100KV CSV file retrieval: 30 seconds approx.
 200KV CSV file retrieval: 60 seconds approx.

Digital I/O Cartridge Specifications

Input Cartridge

Part No.	FC6A-PN4	
Input Points	4 (4/1 common)	
Rated Input Voltage	12/24V DC sink/source input signal	
Input Voltage Range	0 to 28.8V DC	
Rated Input Current	2.5 mA/point (12V DC) 5mA/point (24V DC)	
Input Impedance	4.4 kΩ	
OFF Voltage	5V maximum	
ON Voltage	8.5V minimum	
OFF Current	0.9 mA maximum	
ON Current	1.7 mA minimum (at 8.5V DC)	
Input Delay Time (24V DC)	Turn ON	0.5ms
	Turn OFF	0.5ms
Isolation	Between input terminals: Not isolated Internal circuit: Optocoupler-isolated	
External Load for I/O Interconnection	Not needed	
Signal Determination Method	Static	
Effect of Improper Input Connection	Both sink and source input signals can be connected. If any input exceeding the rated value is applied, permanent damage may be caused.	
Internal Current Draw	All Inputs ON	35mA (3.3V DC) 0mA (24V DC)
	All Inputs OFF	30mA (3.3V DC) 0mA (24V DC)
Internal Power Consumption (at 24V DC while all inputs ON)	0.10W	
Cable Length	3m in compliance with electromagnetic immunity	
Weight (approx.)	15g	

Output Cartridge

Part No.	FC6A-PTK4	FC6A-PTS4
Output Points	4 sink (4/1 common)	4 source (4/1 common)
Rated Input Voltage	12/24V DC	
Input Voltage Range	10.2 to 28.8V DC	
Maximum Load Current	Per Point	0.1A
	Per Common	0.4A
Output Delay	Turn ON	450µs maximum
	Turn OFF	450µs maximum
Isolation	Between input terminals: Not isolated Internal circuit: Optocoupler-isolated	
Voltage Drop (ON Voltage)	1V max (voltage between COM and output terminal when output is on.)	
Inrush Current	1A	
Leakage Current	0.1mA maximum	
Clamping Voltage	Approx. 50V	
Maximum Lamp Load	2.4W	
Inductive Load	L/R=10ms (28.8V DC, 1Hz)	
External Current Draw	100mA maximum, 24V DC (power voltage at the +V terminal at source)	100mA maximum, 24V DC (power voltage at the -V terminal at source)
	Overcurrent Protection: No	
Internal Current Draw	All Outputs ON	35mA (3.3V DC) 0mA (24V DC)
	All Outputs OFF	30mA (3.3V DC) 0mA (24V DC)
Internal Power Consumption (at 24V DC while all outputs ON)	0.10W	
Weight (approx.)	15g	

Analog I/O Cartridge

General Specifications

Part No.	FC6A-PJ2A	FC6A-PJ2CP	FC6A-PK2AV	FC6A-PK2AW
Type	Voltage/Current Input	Temperature Input	Voltage Output	Current Output
No. of Points	2	2	2	2
Rated Voltage	5.0V, 3.3V (supplied from the CPU module)			
Power Consumption	5.0V: — 3.3V: 30mA		5.0V: 70mA 3.3V: 30mA	5.0V: 185mA 3.3V: 30mA
Weight (approx.)	15g			

Lineup **Cartridges**

Plus **Analog I/O Cartridge**
All-in-One **Function Specifications**

Modules	Part No.	FC6A-PJ2A	FC6A-PJ2CP	FC6A-PK2AV	FC6A-PK2AW	
Cartridges	Input Points	2	2	—	—	
	Types of Inputs	Voltage Input	0-10V	—	—	—
Current Input		0-20mA, 4-20mA	—	—	—	
Dimensions	Input Range	Thermocouple	—	K, J, R, S, B, E, T, N, C	—	
		Resistance Thermometer	—	Pt100, Pt1000, NI100, NI1000 3-wire type	—	
Mounting Hole Layout	Input Impedance	Voltage Input	1MΩ minimum	—	—	
		Current Input	250Ω maximum	—	—	
Instructions	Input Impedance	Thermocouple	—	1MΩ minimum	—	
		Resistance Thermometer	—	1MΩ minimum	—	
	Allowable Conductor Resistance (per wire)	Resistance Thermometer	N/A	10Ω maximum	—	
	Type of Input	Single-ended input		—	—	
	Sampling Time	10ms	250ms	—	—	
	Sampling Repetition Time	20ms	500ms	—	—	
	Total Input System Transfer Time	Sampling time + sampling repetition time + 1 scan time		—	—	
	Operation Mode	Self-scan		—	—	
	Conversion Method	SAR		—	—	
Input Error	Maximum Error at 25°C	±0.1% of full scale	±0.1%/°C of full scale Cold junction compensation error: 4.0°C maximum. However, R, S inputs: ±6°C (0 to 200°C) B: 0 to 300°C. Accuracy is not guaranteed. K, J, E, T, N inputs: less than ±0.4% of full scale (0°C)	—	—	
		Temperature Coefficient	±0.02%/°C of full scale	±0.02%/°C of full scale	—	—
	Output Points	—	—	2	2	
Types of Outputs	Voltage Output	—	—	0-10V	—	
	Current Output	—	—	—	4-20mA	
Types of Output Load	Impedance	—	—	2kΩ minimum	500Ω minimum	
	Load Type	—	—	Resistive load	Resistive load	
	DA Conversion Time	—	—	40ms maximum	20ms maximum	
	Output Update Interval	—	—	20ms	20ms	
	Total Output Delay	—	—	DA conversion time + output update time + 1 scan time		
Output Error	Maximum Error at 25°C	—	—	±0.3% of full scale	±0.3% of full scale	
		Temperature Coefficient	—	—	±0.02%/°C of full scale	±0.02%/°C of full scale
	Output Ripple	—	—	30mV maximum	30mV maximum	
	Overshoot	—	—	0%	0%	
Data	Digital Resolution	4,096 increments (12 bits)	Thermocouple input K: approx. 15,000 (14 bits) J: approx. 12,000 (14 bits) R: approx. 17,600 (15 bits) S: approx. 17,600 (15 bits) B: approx. 18,200 (15 bits) E: approx. 10,000 (14 bits) T: approx. 6,000 (13 bits) N: approx. 15,000 (14 bits) C: approx. 23,150 (15 bits) Resistance thermometer input Pt100: approx. 10,500 (14 bits) Pt1000: approx. 8,000 (13 bits) NI100: approx. 2,400 (12 bits) NI1000: approx. 2,400 (12 bits)	4,096 increments (12 bits)	4,096 increments (12 bits)	4,096 increments (12 bits)
	Output Value of LSB	2.44 mV (0-10V) 4.88 μA (0-20mA) 3.91 μA (4-20mA)	0.1°C or 0.18°F (thermocouple input) 0.1°C or 0.18°F (resistor thermometer input)	2.44 mV (0-10V)	3.91 μA (4-20mA)	
	Data Type in Application Program	−32,768 to 32,773 (selectable for each channel) (*2)	−32,768 to 32,773 (selectable for each channel) (*2)	0 to 4,095 (0-10V)	0 to 4,095 (4-20mA)	
	Monotonicity	Yes	Yes	Yes	Yes	
	Current Loop Open	—	—	—	Not detectable	
	Input Data Out of Range	Detectable (*1)	Detectable (*1)	—	—	
Noise Resistance	Recommended Cable	Pair shielded cable	Pair cable	Pair shielded cable	Pair shielded cable	
	Crosstalk	1LSB maximum	1LSB maximum	1LSB	1LSB	
Others	Selection of Output Signal Type	—	—	Voltage output only	Current output only	
	Calibration to Maintain Rated Accuracy	Not possible				
	Effect of Improper Input Connection	No damage	No damage	—	—	
	Effect of Improper Output Connection	—	—	No damage	No damage	

*1) When an error is detected, a corresponding error code is stored to a data register allocated to analog I/O operating status.
*2) The data processed in the analog I/O module can be linear-converted to a value between -32,768 and 32,767. The optional range designation, and analog I/O data minimum and maximum values can be selected using data registers allocated to analog I/O modules.

Cartridges

Lineup

Plus

All-in-One

Modules

Cartridges

Dimensions

Mounting Hole Layout

Instructions

Digital I/O Cartridge Internal Circuit

FC6A-PN4

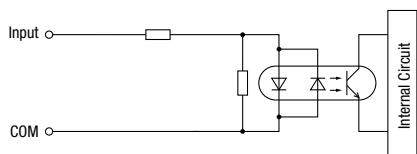

FC6A-PTK4

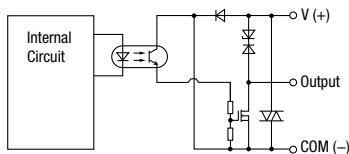

FC6A-PTS4

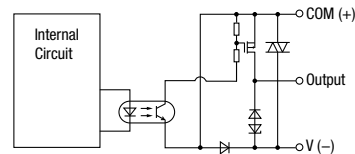

Dimensions

Plus CPU Modules

16 I/Os (8/8)

- FC6A-D16R□CEE
- FC6A-D16K□CEE
- FC6A-D16P□CEE

*1) [] indicates a dimension for Push-in type.
 *2) Push-in type does not have power supply terminal covers.

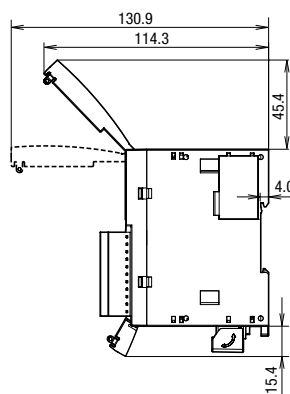
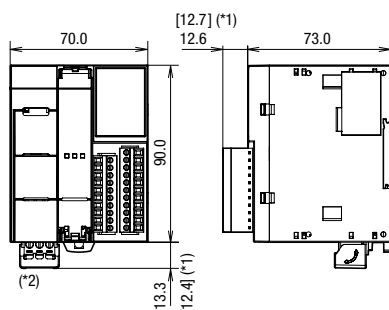

32 I/Os (16/16)

- FC6A-D32K□CEE
- FC6A-D32P□CEE

*1) [] indicates a dimension for Push-in type.
 *2) Push-in type does not have power supply terminal covers.

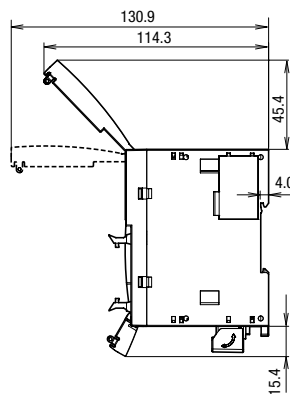
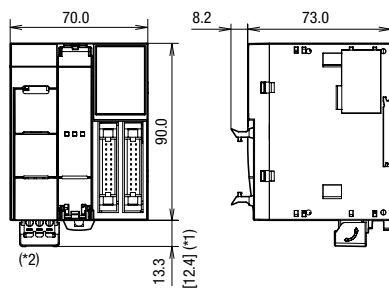

All dimensions in mm.

Note: Specify a terminal type code in place of □ in the Part No. (1: screw fastened type, 3: MIL connector type, 4: Push-in type)

Lineup **Dimensions**

Plus **All-in-One CPU Modules**

All-in-One **16 I/Os (8/8)**

- Modules
 Cartridges
Dimensions
 Mounting Hole Layout
 Instructions
- FC6A-C16R□AE
 - FC6A-C16R□CE
 - FC6A-C16R□DE
 - FC6A-C16P□CE
 - FC6A-C16P□DE
 - FC6A-C16K□CE
 - FC6A-C16K□DE

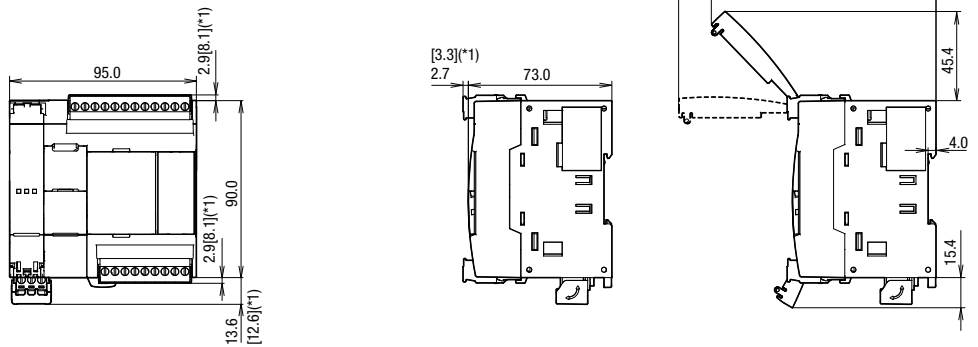

24 I/Os (14/10)

- FC6A-C24R□AE
- FC6A-C24R□CE
- FC6A-C24P□CE
- FC6A-C24K□CE

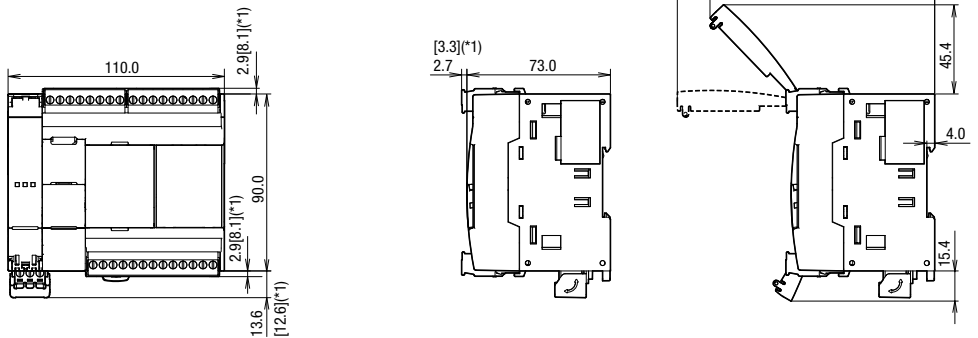

40 I/Os (24/16)

- FC6A-C40R□AE
- FC6A-C40R□CE
- FC6A-C40P□CE
- FC6A-C40K□CE
- FC6A-C40R□DE
- FC6A-C40P□DE
- FC6A-C40K□DE

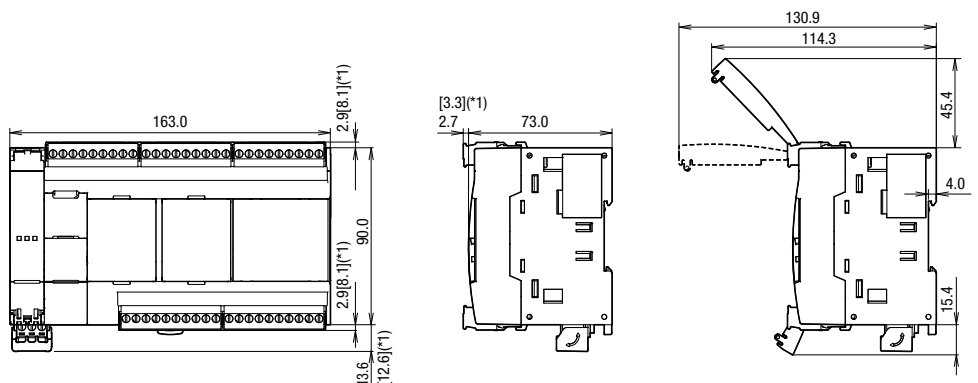

CAN J1939 All-in-One CPU Modules

40 I/Os (24/16)

- FC6A-C40R□AEJ
- FC6A-C40R□CEJ
- FC6A-C40P□CEJ
- FC6A-C40K□CEJ
- FC6A-C40R□DEJ
- FC6A-C40P□DEJ
- FC6A-C40K□DEJ

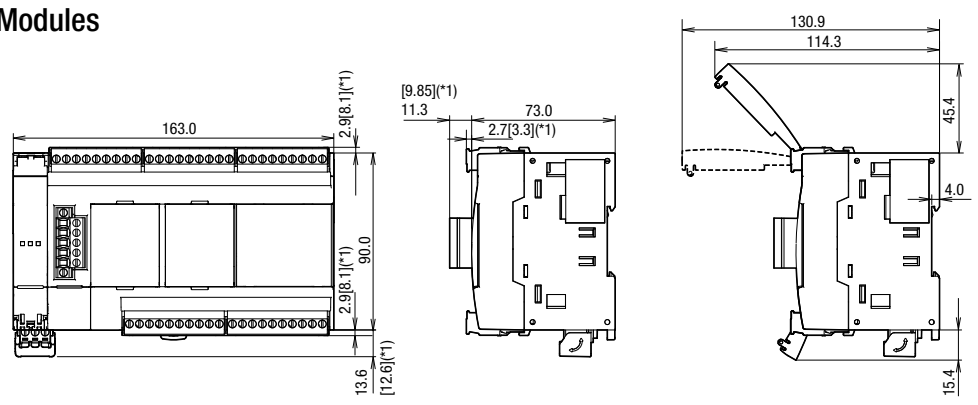

Note: Specify a terminal type code in place of □ in the Part No. (1: screw fastened type, 4: Push-in type)
 *1) [] indicates a dimension for Push-in type.
 *2) Push-in type does not have power supply terminal covers.

All dimensions in mm.

Dimensions

Lineup

Plus

All-in-One

Modules

Cartridges

Dimensions

Mounting Hole Layout

Instructions

HMI Module

FC6A-PH1

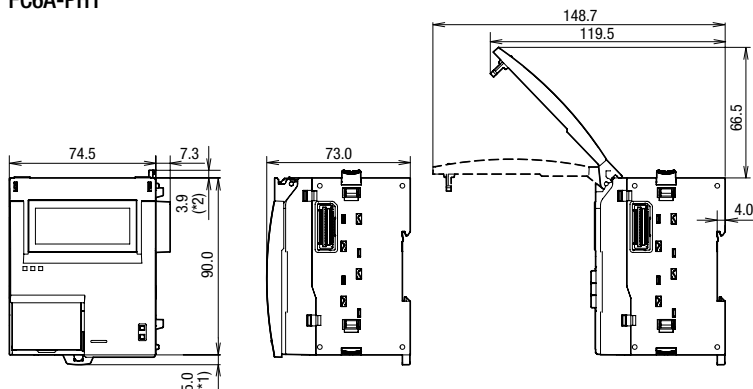

Expansion Interface Modules

Unibody Type

FC6A-EXM2□

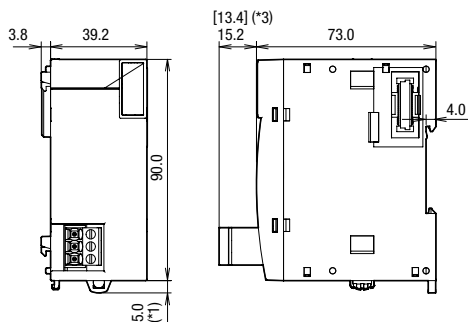

Separate Master Type

FC6A-EXM1M

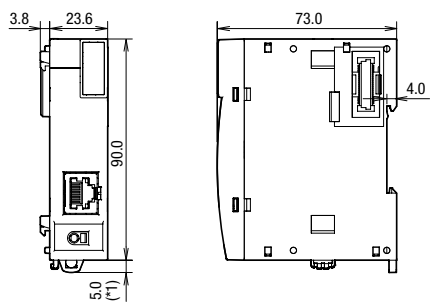

Separate Slave Type

FC6A-EXM1S□

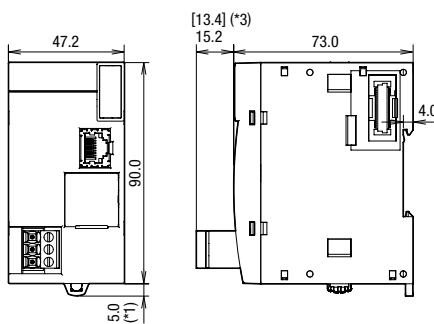

Cartridge Base Module

FC6A-HPH1

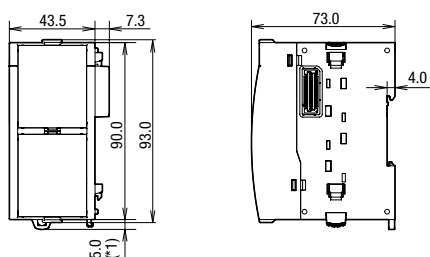

Note: Specify a terminal type code in place of □ in the Part No. (1: screw fastened type, 4: Push-in type)

*1) 9.3 mm when the clamp is pulled out.

*2) 0 mm when the eject button is locked.

*3) [] indicates a dimension for Push-in type.

All dimensions in mm.

Lineup **Dimensions**

- Plus
- All-in-One
- Modules
- Cartridges
- Dimensions**
- Mounting Hole Layout
- Instructions

Expansion Modules

FC6A-N08B□ / FC6A-N08A1□ / FC6A-R08□
 FC6A-T08K□ / FC6A-T08P□ / FC6A-M08BR□
 FC6A-J2C□ / FC6A-K2A□ / FC6A-K4A□
 FC6A-L03CN□

FC6A-N16B□ / FC6A-R16□ / FC6A-T16K□
 FC6A-T16P□ / FC6A-J4A□ / FC6A-J8A□
 FC6A-J4CN□ / FC6A-J4CH□Y / FC6A-J8CU□
 FC6A-L06A□ / FC6A-SIF52□

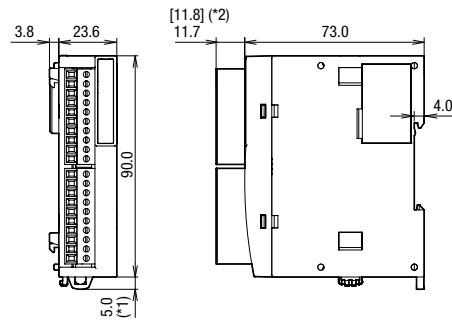
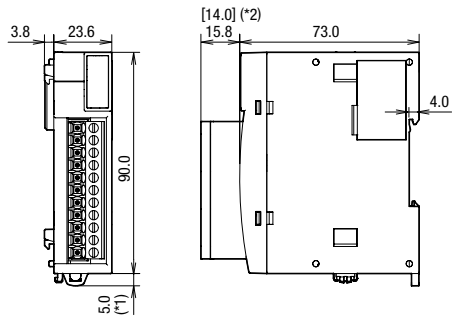

FC6A-N16B3 / FC6A-T16K3
 FC6A-T16P3

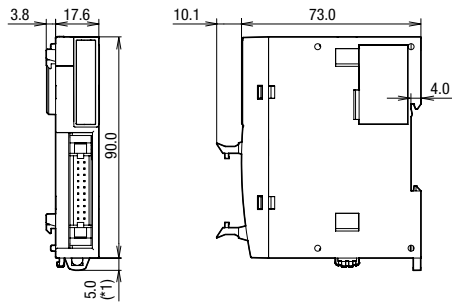

FC6A-N32B3 / FC6A-T32K3
 FC6A-T32P3

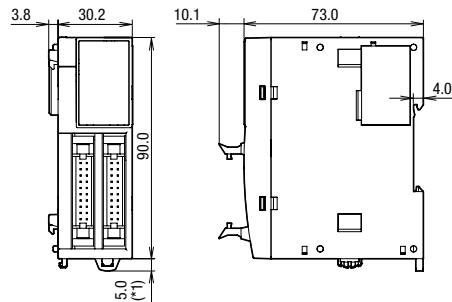

FC6A-M24BR□
 FC6A-F2M□
 FC6A-F2MR□

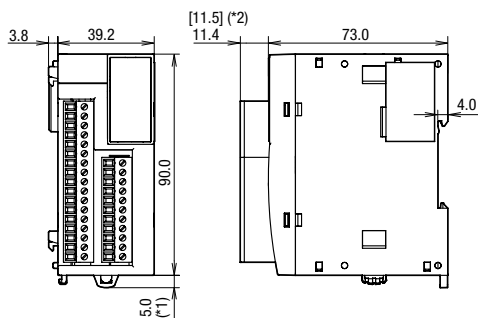

Cartridges

FC6A-PC1 / FC6A-PC3 / FC6A-PJ2A
 FC6A-PK2AV / FC6A-PK2AW / FC6A-PJ2CP
 FC6A-PN4 / FC6A-PTK4 / FC6A-PTS4

FC6A-PC4

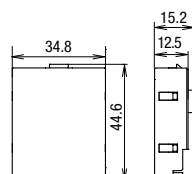
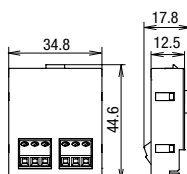

Note: Specify a terminal type code in place of □ in the Part No.
 (blank: screw fastened type, 3: MIL connector type, 4: Push-in type)
 *1) 9.3 mm when the clamp is pulled out.
 *2) [] indicates a dimension for Push-in type.
 Note: See page 5 to 7 for part numbers.

All dimensions in mm.

Mounting Hole Layout

Lineup

Plus

All-in-One

Modules

Cartridges

Dimensions

Mounting Hole Layout

Instructions

All-in-One / CAN J1939 All-in-One CPU Modules

Install FC6A directly to a flat panel using M4 pan head screws.

- FC6A-C16R□AE
- FC6A-C16R□CE
- FC6A-C16R□DE
- FC6A-C16K□CE
- FC6A-C16K□DE
- FC6A-C16P□CE
- FC6A-C16P□DE

- FC6A-C24R□AE
- FC6A-C24R□CE
- FC6A-C24K□CE
- FC6A-C24P□CE

- FC6A-C40R□AE / FC6A-C40R□CE / FC6A-C40K□CE
- FC6A-C40P□CE / FC6A-C40R□DE / FC6A-C40K□DE
- FC6A-C40P□DE / FC6A-C40R□AEJ / FC6A-C40R□CEJ
- FC6A-C40K□CEJ / FC6A-C40P□CEJ / FC6A-C40R□DEJ
- FC6A-C40K□DEJ / FC6A-C40P□DEJ

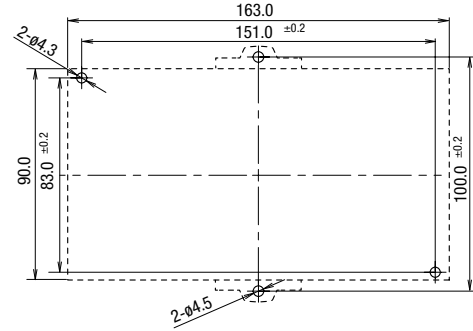
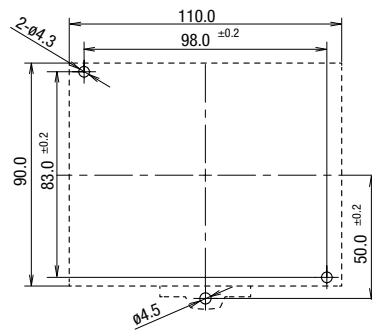
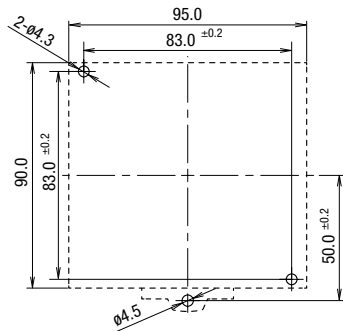

Plus CPU Modules

- FC6A-D16R□CEE
- FC6A-D16K□CEE
- FC6A-D16P□CEE
- FC6A-D32K□CEE
- FC6A-D32P□CEE

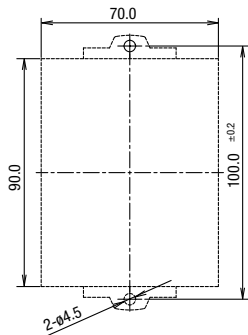

Expansion Modules

FC6A-PH1

FC6A-EXM1S□

FC6A-HPH1

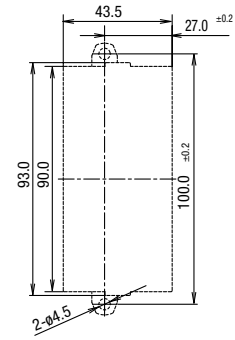
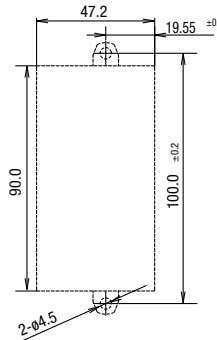
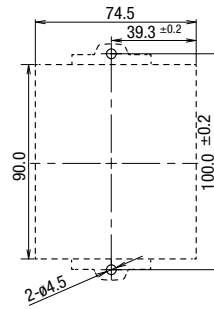

- FC6A-N16B3
- FC6A-T16K3
- FC6A-T16P3

- FC6A-N32B3
- FC6A-T32K3
- FC6A-T32P3

- FC6A-F2M□
- FC6A-F2MR□
- FC6A-EXM2□

- FC6A-SIF52□
- FC6A-EXM1M
- FC6A-N08B□
- FC6A-N08A1□
- FC6A-R08□
- FC6A-T08K□
- FC6A-T08P□
- FC6A-M08BR□
- FC6A-N16B□
- FC6A-R16□
- FC6A-T16K□
- FC6A-T16P□
- FC6A-J2C□
- FC6A-K2A□
- FC6A-K4A□
- FC6A-L03CN□
- FC6A-J4A□
- FC6A-J8A□
- FC6A-J4CN□
- FC6A-J4CH□Y
- FC6A-J8CU□
- FC6A-L06A□

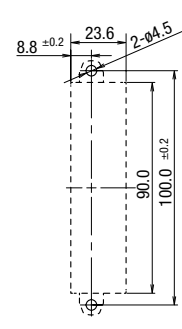
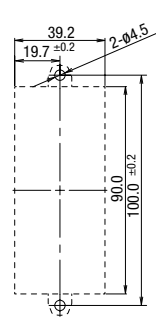
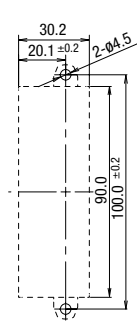
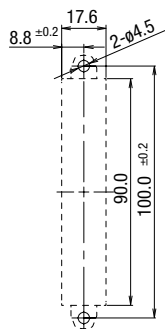

Note: Specify a terminal type code in place of □ in the Part No.
 (blank: screw fastened type, 3: MIL connector type, 4: Push-in type)
 Note: See page 4 to 7 for part numbers.

All dimensions in mm.

Lineup
Plus
All-in-One
Modules
Cartridges
Dimensions
Mounting Hole Layout
Instructions

Instructions

Basic Instructions

Symbol	Function	Instruction Length (byte) (*1)	
		When using bit device	When using data register
AND	Series connection of NO contact	8	2
AND-LOD	Series connection of circuit blocks	8	
ANDN	Series connection of NC contact	12	
BPP	Restores the result of bit logical operation which was saved temporarily	4	
BPS	Saves the result of bit logical operation temporarily	4	
BRD	Reads the result of bit logical operation which was saved temporarily	4	
CC=	Equal to comparison of counter current value	12 to 16	
CC≥	Greater than or equal to comparison of counter current value	12 to 16	
CDP	Dual pulse reversible counter (0 to 65,535)	12 to 16	
CDPD	Double-word dual pulse reversible counter (0 to 4,294,967,295)	12 to 16	
CNT	Adding counter (0 to 65,535)	12 to 16	
CNTD	Double-word adding counter (0 to 4,294,967,295)	12 to 16	
CUD	Up/down selection reversible counter (0 to 65,535)	12 to 16	
CUDD	Double-word up/down selection reversible counter (0 to 4,294,967,295)	12 to 16	
DC=	Equal to comparison of data register value	12 to 24	
DC≥	Greater than or equal to comparison of data register value	12 to 24	
END	Ends a program	4	
JEND	Ends a jump instruction	4	
JMP	Jumps a designated program area	12	
LOD	Stores intermediate results and reads contact status	8	12
LODN	Stores intermediate results and reads inverted contact status	12	
MCR	Ends a master control	4	
MCS	Starts a master control	4	
OR	Parallel connection of NO contact	8	12
OR-LOD	Parallel connection of circuit blocks	8	
ORN	Parallel connection of NC contact	12	
OUT	Outputs the result of bit logical operation	8	
OUTN	Output the inverted result of bit logical operation	8	
RST	Reset	8	
SET	Set	8	
SFR	Forward shift register	12	
SFRN	Reverse shift register	12	
SOTD	Falling-edge differentiation output	8	
SOTU	Rising-edge differentiation output	8	
TIM	Subtracting 100-ms timer (0 to 6553.5 sec)	12 to 16	
TIMO	Subtracting 100-ms off-delay timer (0 to 6553.5 sec)	12 to 16	
TMH	Subtracting 10-ms timer (0 to 655.35 sec)	12 to 16	
TMHO	Subtracting 10-ms off-delay timer (0 to 655.35 sec)	12 to 16	
TML	Subtracting 1-sec timer (0 to 65535 sec)	12 to 16	
TMLO	Subtracting 1-sec off-delay timer (0 to 65535 sec)	12 to 16	
TMS	Subtracting 1-ms timer (0 to 65.535 sec)	12 to 16	
TMSO	Subtracting 1-ms off-delay timer (0 to 65.535 sec)	12 to 16	

*1) 1 step = 8 bytes

Instructions

Lineup

Plus

All-in-One

Modules

Cartridges

Dimensions

Mounting Hole
Layout

Instructions

Advanced Instructions

Symbol	Function
NOP	No Operation
MOV	Move
MOVC	Move Character
MOVN	Move Not
IMOV	Indirect Move
IMOVN	Indirect Move Not
BMOV	Block Move
IBMV	Indirect Bit Move
IBMVN	Indirect Bit Move Not
NSET	N Data Set
NRS	N Data Repeat Set
XCHG	Exchange
TCCST	Timer/Counter Current Value Store
CMP=	Compare Equal To
CMP<>	Compare Unequal To
CMP<	Compare Less Than
CMP>	Compare Greater Than
CMP<=	Compare Less Than or Equal To
CMP>=	Compare Greater Than or Equal To
ICMP>=	Interval Compare Greater Than or Equal
LC=	Load Compare Equal To
LC<>	Load Compare Unequal To
LC<	Load Compare Less Than
LC>	Load Compare Greater Than
LC<=	Load Compare Less Than or Equal To
LC<=	Load Compare Greater Than or Equal To
ADD	Addition
SUB	Subtraction
MUL	Multiplication
DIV	Division
INC	Increment
DEC	Decrement
ROOT	Root
SUM	Sum
RNDM	Random
ANDW	AND Word
ORW	OR Word
XORW	Exclusive OR Word
SFTL	Shift Left
SFTR	Shift Right
BCDLS	BCD Left Shift
WSFT	Word Shift
ROTL	Rotate Left
ROTR	Rotate Right
HTOB	Hex to BCD
BTOH	BCD to Hex
HTOA	Hex to ASCII
ATOH	ASCII to Hex
BTOA	BCD to ASCII
ATOB	ASCII to BCD
ENCO	Encode
DECO	Decode
BCNT	Bit Count
ALT	Alternate Output
CVDT	Convert Data Type
DTDV	Data Divide
DTCB	Data Combine
SWAP	Data Swap

Lineup **Instructions**

Plus **Advanced Instructions**

All-in-One

Modules

Cartridges

Dimensions

Mounting Hole
Layout

Instructions

Symbol	Function
WEEK	Weekly Timer
YEAR	Yearly Timer
WKTIM	Week Timer
WKTBL	Week Table
MSG	Message
DISP	Display
DGRD	Digital Read
TXD	Transmit
ETXD	Transmit over Ethernet
RXD	Receive
ERXD	Transmit over Ethernet
LABEL	Label
LJMP	Label Jump
LCAL	Label Call
LRET	Label Return
DJNZ	Decrement Jump Non-zero
DI	Disable Interrupt
EI	Enable Interrupt
IOREF	I/O Refresh
HSCRF	High-speed Counter Refresh
FRQRF	Frequency Measurement Refresh
COMRF	Communication Refresh
XYFS	XY Format Set
CVXTY	Convert X to Y
CVYTX	Convert Y to X
AVRG	Average
PULS	Pulse Output
PWM	Pulse Width Modulation
RAMP	Ramp Pulse Output
RAMPL	Linear Interpolation with RAMP Pulse Output (*1)
ZRN	Zero Return
ARAMP	Advanced Ramp
ABS	Set the origin
JOG	Pulse with direction
PID	PID Control (FC5A compatible)
PIDA	PID Control
PIDD	PID with Derivative Decay
DTML	1-sec Dual Timer
DTIM	100-ms Dual Timer
DTMH	10-ms Dual Timer
DTMS	1-ms Dual Timer
TTIM	Teaching Timer
RAD	Degree to Radian
DEG	Radian to Degree
SIN	Sine
COS	Cosine
TAN	Tangent
ASIN	Arc Sine
ACOS	Arc Cosine
ATAN	Arc Tangent
LOGE	Natural Logarithm
LOG10	Common Logarithm
EXP	Exponent
POW	Power
FIFO	FIFO Format
FIEX	First-In Execute
FOEX	First-Out Execute
NDSRC	N Data Search

*1) Cannot be used on All-in-One model.

Instructions

Symbol	Function
TADD	Time Addition
TSUB	Time Subtraction
HTOS	HMS to Sec
STOH	Sec to HMS
HOUR	Hour Meter
SCRPT	Script
UMACRO	User-defined Macro
SCALE	Convert Analog Input
FLWA	Analog Flow Totalizer
FLWP	Pulse Flow Totalizer
PING	Ping
EMAIL	Send Email (*2)
DLOG	Data Logging
TRACE	Data Trace

*2) HMI module is necessary to use on All-in-One model.

Lineup

Plus

All-in-One

Modules

Cartridges

Dimensions

Mounting Hole
Layout

Instructions

Ordering Terms and Conditions

Thank you for using IDEC Products.

By purchasing products listed in our catalogs, datasheets, and the like (hereinafter referred to as "Catalogs") you agree to be bound by these terms and conditions. Please read and agree to the terms and conditions before placing your order.

1. Notes on contents of Catalogs

- (1) Rated values, performance values, and specification values of IDEC products listed in this Catalog are values acquired under respective conditions in independent testing, and do not guarantee values gained in combined conditions.
Also, durability varies depending on the usage environment and usage conditions.
- (2) Reference data and reference values listed in Catalogs are for reference purposes only, and do not guarantee that the product will always operate appropriately in that range.
- (3) The specifications / appearance and accessories of IDEC products listed in Catalogs are subject to change or termination of sales without notice, for improvement or other reasons.
- (4) The content of Catalogs is subject to change without notice.

2. Note on applications

- (1) If using IDEC products in combination with other products, confirm the applicable laws / regulations and standards.
Also, confirm that IDEC products are compatible with your systems, machines, devices, and the like by using under the actual conditions. IDEC shall bear no liability whatsoever regarding the compatibility with IDEC products.
- (2) The usage examples and application examples listed in Catalogs are for reference purposes only. Therefore, when introducing a product, confirm the performance and safety of the instruments, devices, and the like before use. Furthermore, regarding these examples, IDEC does not grant license to use IDEC products to you, and IDEC offers no warranties regarding the ownership of intellectual property rights or non-infringement upon the intellectual property rights of third parties.
- (3) When using IDEC products, be cautious when implementing the following.
 - i. Use of IDEC products with sufficient allowance for rating and performance
 - ii. Safety design, including redundant design and malfunction prevention design that prevents other danger and damage even in the event that an IDEC product fails
 - iii. Wiring and installation that ensures the IDEC product used in your system, machine, device, or the like can perform and function according to its specifications
- (4) Continuing to use an IDEC product even after the performance has deteriorated can result in abnormal heat, smoke, fires, and the like due to insulation deterioration or the like. Perform periodic maintenance for IDEC products and the systems, machines, devices, and the like in which they are used.
- (5) IDEC products are developed and manufactured as general-purpose products for general industrial products. They are not intended for use in the following applications, and in the event that you use an IDEC product for these applications, unless otherwise agreed upon between you and IDEC, IDEC shall provide no guarantees whatsoever regarding IDEC products.
 - i. Use in applications that require a high degree of safety, including nuclear power control equipment, transportation equipment (railroads / airplanes / ships / vehicles / vehicle instruments, etc.), equipment for use in outer space, elevating equipment, medical instruments, safety devices, or any other equipment, instruments, or the like that could endanger life or human health
 - ii. Use in applications that require a high degree of reliability, such as provision systems for gas / waterworks / electricity, etc., systems that operate continuously for 24 hours, and settlement systems
 - iii. Use in applications where the product may be handled or used deviating from the specifications or conditions / environment listed in the Catalogs, such as equipment used outdoors or applications in environments subject to chemical pollution or electromagnetic interference
If you would like to use IDEC products in the above applications, be sure to consult with an IDEC sales representative.

3. Inspections

We ask that you implement inspections for IDEC products you purchase without delay, as well as thoroughly keep in mind management/maintenance regarding handling of the product before and during the inspection.

4. Warranty

(1) Warranty period

The warranty period for IDEC products shall be one (1) year after purchase or delivery to the specified location. However, this shall not apply in cases where there is a different specification in the Catalogs or there is another agreement in place between you and IDEC.

(2) Warranty scope

Should a failure occur in an IDEC product during the above warranty period for reasons attributable to IDEC, then IDEC shall replace or repair that product, free of charge, at the purchase location / delivery location of the product, or an IDEC service base. However, failures caused by the following reasons shall be deemed outside the scope of this warranty.

- i. The product was handled or used deviating from the conditions / environment listed in the Catalogs
- ii. The failure was caused by reasons other than an IDEC product
- iii. Modification or repair was performed by a party other than IDEC
- iv. The failure was caused by a software program of a party other than IDEC
- v. The product was used outside of its original purpose
- vi. Replacement of maintenance parts, installation of accessories, or the like was not performed properly in accordance with the user's manual and Catalogs
- vii. The failure could not have been predicted with the scientific and technical standards at the time when the product was shipped from IDEC.
- viii. The failure was due to other causes not attributable to IDEC (including cases of force majeure such as natural disasters and other disasters)

Furthermore, the warranty described here refers to a warranty on the IDEC product as a unit, and damages induced by the failure of an IDEC product are excluded from this warranty.

5. Limitation of liability

The warranty listed in this Agreement is the full and complete warranty for IDEC products, and IDEC shall bear no liability whatsoever regarding special damages, indirect damages, incidental damages, or passive damages that occurred due to an IDEC product.

6. Service scope

The prices of IDEC products do not include the cost of services, such as dispatching technicians. Therefore, separate fees are required in the following cases.

- (1) Instructions for installation / adjustment and accompaniment at test operation (including creating application software and testing operation, etc.)
- (2) Maintenance inspections, adjustments, and repairs
- (3) Technical instructions and technical training
- (4) Product tests or inspections specified by you

The above content assumes transactions and usage within your region. Please consult with an IDEC sales representative regarding transactions and usage outside of your region. Also, IDEC provides no guarantees whatsoever regarding IDEC products sold outside your region.

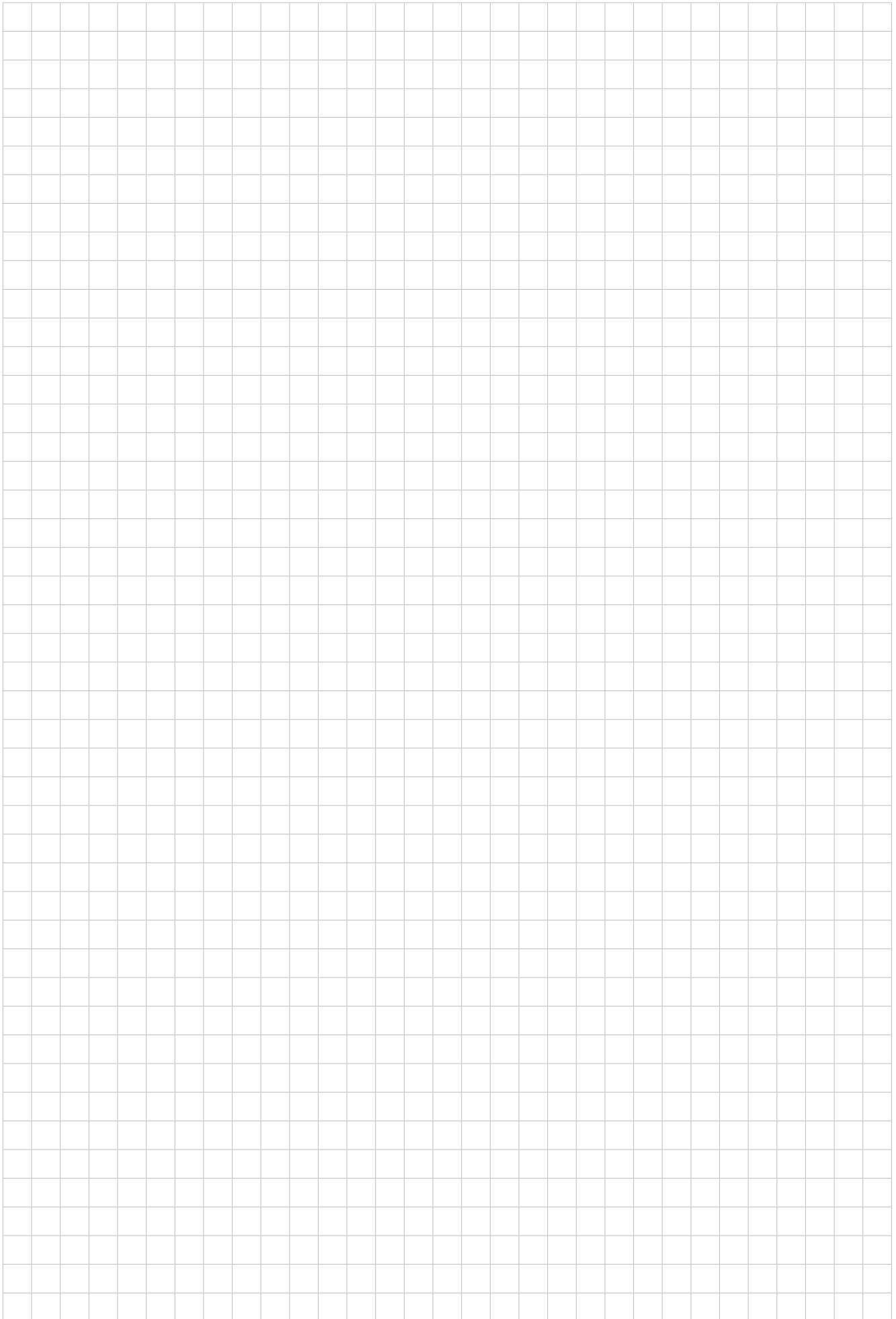

IDEC CORPORATION

 www.idec.com

Head Office 6-64, Nishi-Miyahara-2-Chome, Yodogawa-ku, Osaka 532-0004, Japan

USA IDEC Corporation
EMEA APEM SAS

Singapore IDEC Izumi Asia Pte. Ltd.
Thailand IDEC Asia (Thailand) Co., Ltd.
India IDEC Controls India Private Ltd.

China IDEC (Shanghai) Corporation
IDEC Izumi (H.K.) Co., Ltd.
Taiwan IDEC Taiwan Corporation

Japan IDEC Corporation

Specifications and other descriptions in this brochure are subject to change without notice.
Information in this brochure is current as of June, 2023.
2023 IDEC Corporation, All Rights Reserved.

EP1624-15

