

[PELTIER-KÜHLGERÄT PK 100]

[THERMOELECTRIC COOLER PK 100]



Bezeichnung Type	Beschreibung Description
PK 100	Peltier-Kühlgerät Standard (Anschlussklemme vierpolig) Standard Thermoelectric cooler (terminal four pole)
PK 100 HK (PK 100-4X)	Peltier-Kühlgerät, Heizen und Kühlen (Anschlussklemme sechspolig) Thermoelectric cooler, heating and cooling (terminal six pole) Zulassung Nema 4X optional erhältlich / Approval Nema 4X optionally available
PK 100 HK + AG	Peltier-Kühlgerät, Heizen und Kühlen, mit Aufbaugehäuse (Anschlussklemme sechspolig) Thermoelectric cooler, heating and cooling with additional housing (terminal six pole)

TECHNISCHE DATEN TECHNICAL DATA

Bezeichnung Type	PK 100	PK 100 HK**	PK 100 HK + AG
Artikelnummer Part number	40 P10 570	40 P10 57H	40 P10 57HAG
Betriebsspannung Operating voltage	24 V DC* Use NEC Class 2 power supply	24 V DC* Use NEC Class 2 power supply	24 V DC* Use NEC Class 2 power supply
Eingangs-Spannungsbereich Input voltage range	18 - 26 V DC	18 - 26 V DC	18 - 26 V DC
Stromaufnahme Amperage	5,2 A	5,2 A	5,2 A
Anlaufstrom Starting current	7,5 A	7,5 A	7,5 A
Vorsicherung Fuse	10 A (T)	10 A (T)	10 A (T)
Kühlleistung bei $\Delta^t = 0$ Kelvin Cooling capacity at $\Delta^t = 0$ Kelvin	100 W	100 W	100 W
Heizleistung Heating capacity	-	140 W	140 W
Nennleistung Nominal power	125 W	125 W	125 W
Schalldruck Sound pressure	64 dB(A) @1m	64 dB(A) @1m	64 dB(A) @1m
Luftvolumenstrom Air volume flow	80 m ³ /h	80 m ³ /h	80 m ³ /h
Schutzart Degree of protection	IP67	IP67**	IP65
Lebensdauer Service life	60.000 h	60.000 h	60.000 h
Gewicht Weight	7200 gr.	7200 gr.	8800 gr.
Einsatztemperatur Operating temperature	-20 °C ... +70 °C	-20 °C ... +70 °C	-20 °C ... +70 °C
Zulassungen Approval	UL, CE	UL, CE	UL, CE

* Auch in 12 V DC verfügbar / Also available in 12 V DC

**Nema 4X auf Anfrage erhältlich / Nema 4X available on request

EIGENSCHAFTEN

- Thermoelektrische Kühlung ohne Kältemittel
- Einbau in jeder Lage möglich
- Robust gegen widrige Umgebungsbedingungen
- Hohe Schutzart und robustes Edelstahl-Design
- Platzsparend
- Perfekt für die mobilen Anwendungen geeignet
- Als Option ist Kühlen und Heizen möglich

FEATURES

- Thermoelectric cooling without liquid refrigerant
- Installation possible in any position
- Resistant to adverse environment conditions
- High degree of protection and robust stainless-steel design
- Compact, small dimensions
- Perfect for mobile applications
- Optional cooling and heating is possible

LIEFERUMFANG

- Peltier-Kühlgerät
- Befestigungsschrauben
- Betriebsanleitung

DELIVERY CONTENTS

- Thermoelectric cooler
- Fastening screws
- Instruction manual

LEISTUNGSDIAGRAM PERFORMANCE CURVE

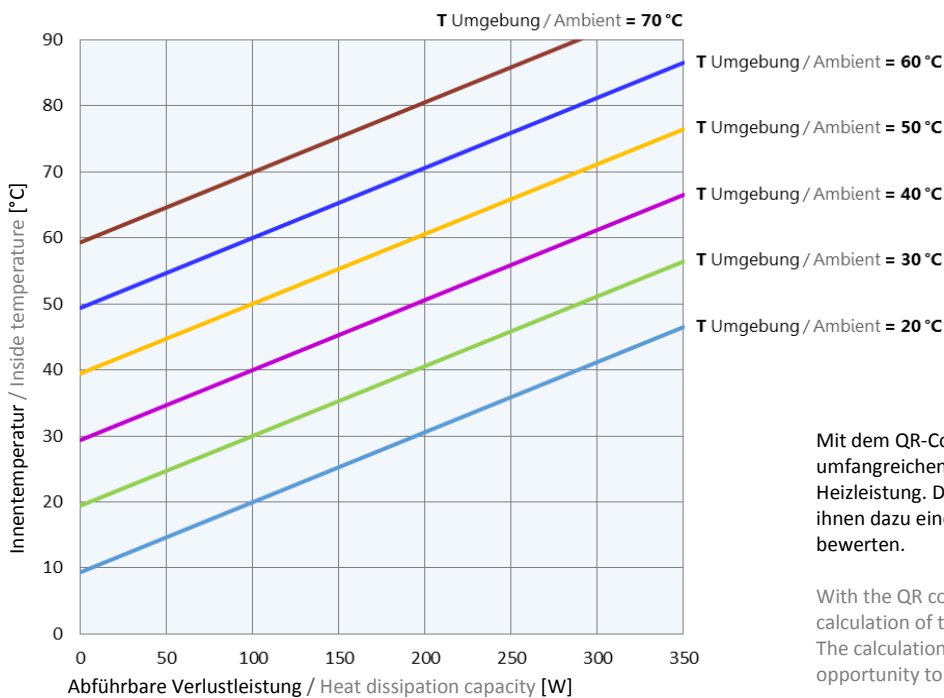

Mit dem QR-Code haben Sie direkten Zugang zur umfangreichen Berechnung der benötigten Kühl- und Heizleistung. Die Berechnungssoftware DELTA T bietet Ihnen dazu eine gute Möglichkeit, Ihr Projekt genau zu bewerten.

With the QR code you have direct access to the extensive calculation of the required cooling and heating capacity. The calculation software DELTA T offers you a good opportunity to evaluate your project precisely.

ABMESSUNGEN DIMENSIONS

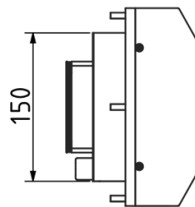
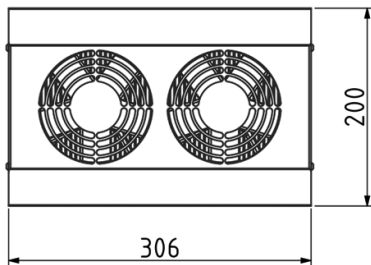
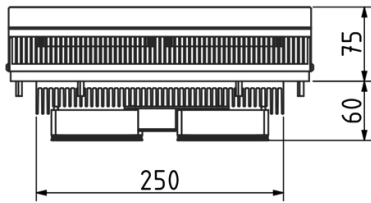



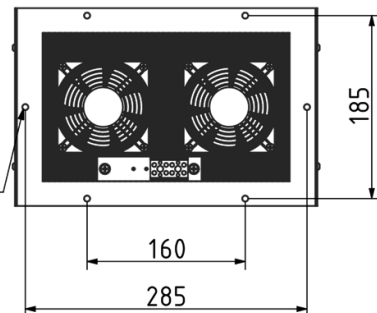

6x Gewindebolzen M6
6x M6 threaded bolts

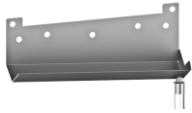

Alle Maße in mm All dimensions in mm

ZUBEHÖR ACCESSORIES

Bezeichnung Type	Beschreibung Description	Artikelnummer Part number	
Emparro 10	Netzteil Emparro 10 Power supply Emparro 10	42 10A 500	
TES 60	Thermostat TES60 Thermostat TES60	15 TES 060	
TRP 205	Thermostat TRP 205, Heizen + Kühlen Thermostat TRP 205, heating + cooling	45 TRP 205	
TRP 260	Temperatursteuerung TRP 260 Temperature control TRP 260	45 TRP 260	
KRP 200	Kondensatrinne für Peltier-Kühlgerät Condensate through for thermoelectric coolers	49 KRP 200	
KRP 300	Kondensatrinne für Peltier-Kühlgerät Condensate through for thermoelectric coolers	49 KRP 300	
AVDR4SS4	Kondensatablaufstutzen Edelstahl Condensate vent drain stainless steel	AVDR4SS4	
AVDR4NM	Kondensatablaufstutzen Kunststoff Condensate vent drain plastic	AVDR4NM	