

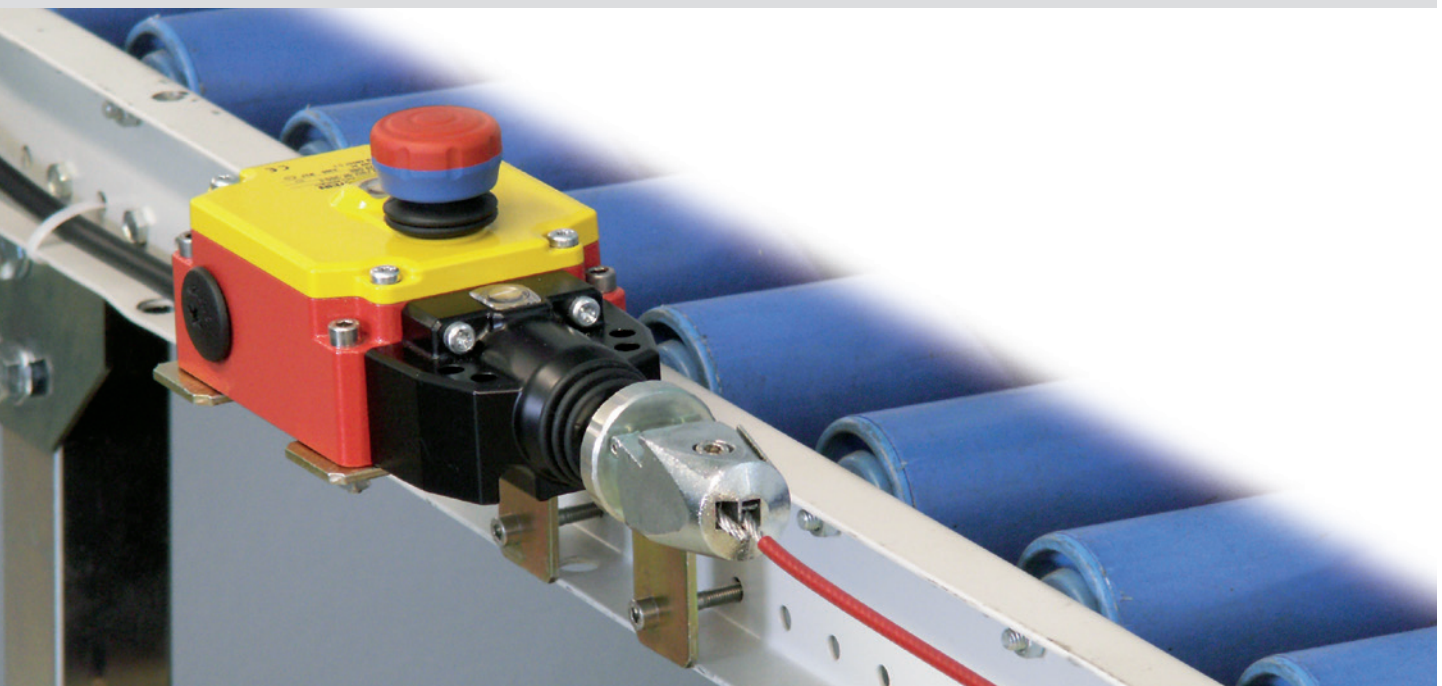

Safety Rope Pull Switches SR and SRM

Safety Rope Pull Switches – For more safety on the production line

Whether on the conveyor belt or on the machine – when maximum safety is required, BERNSTEIN rope pull switches provide a proven and reliable technical solution. The switches can be deployed flexibly, are easy to install and convenient to handle. And most importantly: they offer maximum safety when it is needed.



The SR and SRM series of safety rope pull switching devices developed and manufactured by BERNSTEIN AG are designed and approved in accordance with the standards IEC 947-5-5, IEC 60947-5-5 and ISO 13850. On actuation or in the event of cable breakage, the emergency stop switching device locks automatically and can only be reset to its initial setting by using the resetting device on the switch.

Before using the rope pull emergency stop switch, a risk assessment in accordance with ISO 13850 must be carried out. The European standard requires a possible triggering of the emergency stop signal by pulling the rope in each actuation direction. This is realised by the integration of a return spring (see page 5) in the system.

A standard compliant system can be simply and easily installed using the safety rope pull emergency stop switches SR / SRM and the appropriate return spring.

Advantages

- Rope status display allows fast and correct setting and inspection
- Integrated emergency stop impact button (optional for SR)
- Easy to use with a double function palm button (emergency stop and pull release)
- Economical installation due to the Quick-Fix clamping head
- A cover over the mechanical parts ensures the switches are tamper-proof
- Connection area and mechanical components are separate for extra safety
- Flexible application due to different lengths
- Manufactured in accordance with standards IEC 60947-5-1:
 - IEC 60947-5-5
 - ISO 13850
- DGUV, cCSAus and CCC approval



Application Example

Security at the airport



The BERNSTEIN safety rope pull switch is used in boarding bridges designed to ensure passengers can safely board and alight aircraft at airports throughout the world.

Even in the harsh environment of an airport where the safety requirements are increased, the SRM offers safety when it counts.

Under hazardous situations, the passenger boarding bridge can be stopped at any time and from any position by pulling the rope.

Faster, easier, more cost-efficient – quick clamping device Quick-Fix



The advantage of this system is not only the removal of the otherwise necessary cable eye stiffeners, cable grips and turnbuckles, but also the drastic reduction of the time required to install the cable.

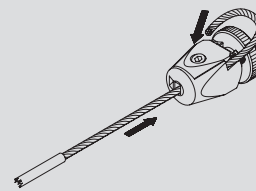

Remove sheath
in clamping range

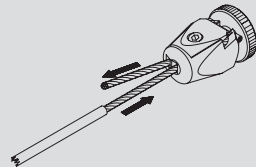

Insert rope into the
quick fastening head

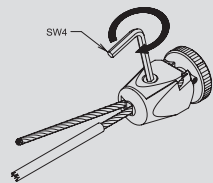

Secure clamping
head with hexagon
socket screw SW 4

Two rope pull return springs with the Quick-Fix quick-connect system are available as accessories:

- Rope pull counter-spring 391.1042.153 for SR...100/SR...175/SRM...175
- Rope pull counter-spring 391.1042.154 for SR...300/SRM...300

For further accessories, please see our main catalogue.

Complete assembly

A span of up to 75 metres can be achieved by using BERNSTEIN safety rope pull switches.

Type- and temperature-related – for further accessories, please see our main catalogue.

When a counter-spring is not used, temperature specifications must be halved.

	Span L max. in metres [m]																																						
	1	2	3	4	5	6	7	8	9	10	11	12	13	14	15	16	17	18	19	20	22	24	26	28	30	32	34	36	38	40	42	44	46	48	50	55	60	65	70
max. temperature variation in Kelvin (K)	+/- 80 K; +/- 110 K																																						
	+/- 70 K; +/- 100 K																																						
	+/- 60 K; +/- 90 K																																						
	+/- 50 K; +/- 70 K																																						
	+/- 40 K; +/- 50 K																																						
	+/- 30 K; +/- 40 K																																						
	+/- 20 K; +/- 26 K																																						
	+/- 10 K; +/- 14 K																																						
+/- 7 K; +/- 9 K																																							
SR...100	Max. span 25 metres																																						
SR...175/SRM...175	Max. span 37.5 metres																																						
SR...300/SRM...300	Max. span 75 metres																																						

Additional features

Safety Rope Pull Switches SR and SRM



Switching status indicator (SRM)

Highly readable switching status indicator located on the switch.

Yellow in the inspection window indicates locking status.

Green in the inspection window indicates operational readiness.

Normal operation

Rope actuation by operator –
Latch automatically

Rope rupture –
Latch automatically

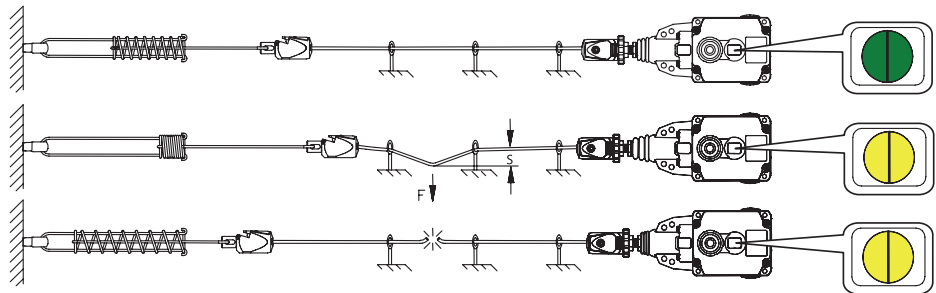

Double function of palm button (SR / SRM)

The BERNSTEIN rope pull switch emergency stop buttons provide emergency stop function and pull release on actuation or in the event of cable breakage.

The SR series offers a choice of pull release or emergency stop function + pull release.

Switches with this dual function are marked with "NA" in the designation.



Rope status display (SR / SRM)

Rope status display for set-up and maintenance.

Adjustment indicator for correct setting of the rope tension.

**Rope too tight
(influence of cold)**

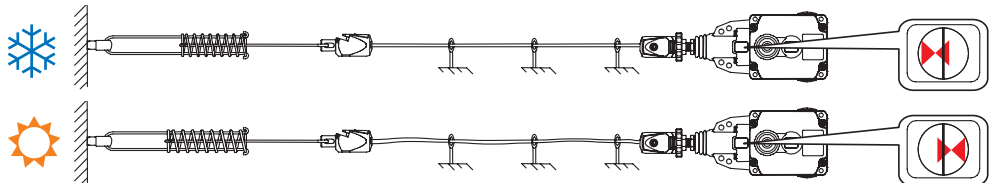

**Rope too slack
(influence of heat)**

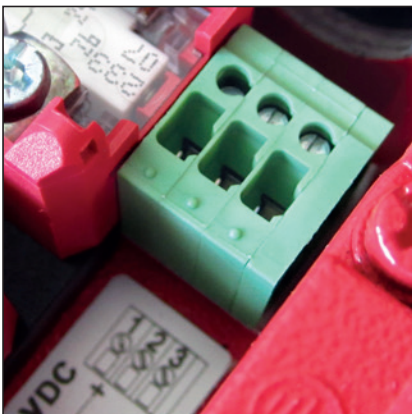
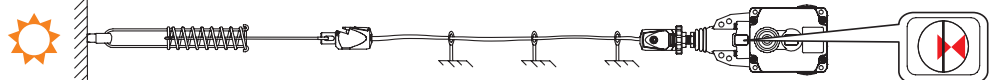

Teleindication for monitoring the rope tension (SRM)

Critical rope conditions caused by any change in length of the rope are reported via an integrated sensor. Unnecessary downtime of the machine can be avoided by appropriately readjusting the tension.

This signal is not highly safety critical.

BERNSTEIN also offers additional indicator lights as optional extras.

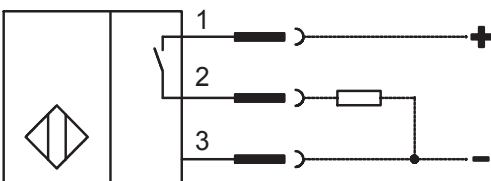

- Rated operating voltage U_e 24 V DC
- Rated operating current I_e 50 mA
- Utilisation category DC-13
- Protected against polarity reversal and short-circuits

The weather-proof all-rounder – SRM rope pull switch

Even under extreme conditions, such as major temperature fluctuations, the SRM rope pull switch continues to work reliably.

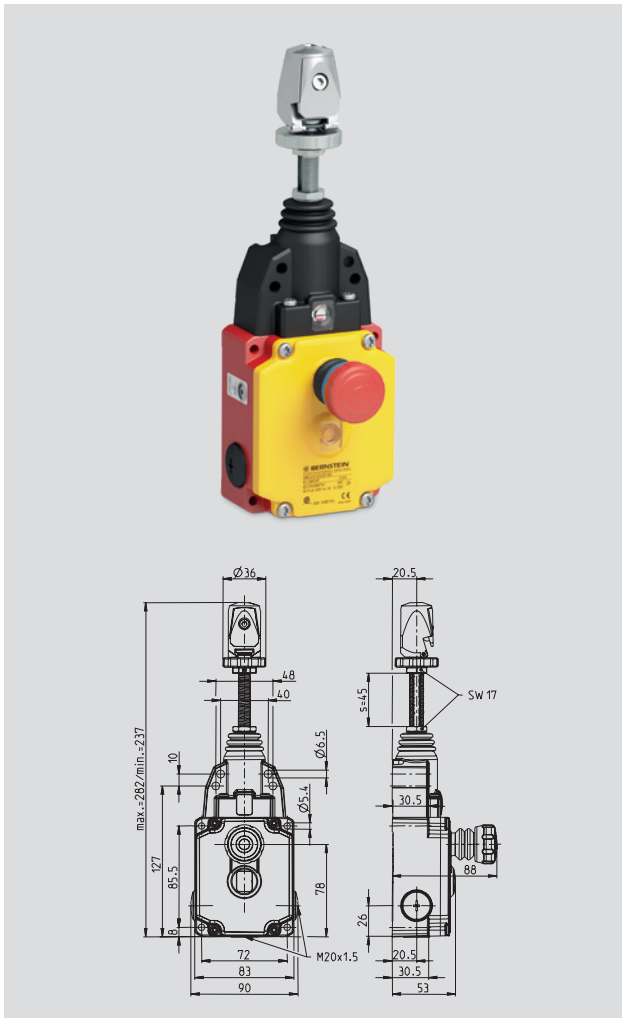

Product description

- Rope pull switch manufactured in accordance with IEC 60947-5-5 and ISO 13850
- Protection class IP67
- Stable and durable metal housing (Aluminium pressure die-casting)
- Suitable for outdoor use
- Can be deployed at temperatures between -30 °C and $+80\text{ °C}$
- Easy to fasten due to hole template patterns common for most rope pull switch models
- Flexible handling with three M20 x 1.5 cable entries
- Easy installation due to the maximum connection space
- Up to four positively driven NC contacts (→)
- Separate-action built-in switches
- AS-i Safety at Work versions available

Technical data SRM

- Rated insulation voltage U_i 250 V AC
- Rated operating voltage U_e 240 V
- Utilization category / switching capacity:
AC-15, 240 V / 3 A ; 120 V / 6 A
DC-13, 250 V / 0,27 A ; 125 V / 0,55 A
- Mechanical switching frequency max. $\leq 20/\text{min.}$
- Mechanical service life 1×10^5 switching cycles
- B10d: 2×10^5 million
- Admissible ambient temperature -30 °C to $+80\text{ °C}$
- Protection class IP67 in accordance with IEC 60529
- Aluminium pressure die-casting enclosure

Order data

SRM

Article number *	Designation	Contact type	Max. span length **	Features
6012929087	SRM-U1Z/U1Z-QF-300	2NC / 2NO	75 m	Quick-Fix QF
6012999096	SRM-A2Z/U1Z-QF-300	3NC / 1NO	75 m	Quick-Fix QF
6012929088	SRM-U1Z/U1Z-QF-300-E	2NC / 2NO	75 m	Quick-Fix QF, remote indicator E
6012999097	SRM-A2Z/U1Z-QF-300-E	3NC / 1NO	75 m	Quick-Fix QF, remote indicator E
6012929085	SRM-U1Z/U1Z-QF-175	2NC / 2NO	37,5 m	Quick-Fix QF
6012999094	SRM-A2Z/U1Z-QF-175	3NC / 1NO	37,5 m	Quick-Fix QF
6012929086	SRM-U1Z/U1Z-QF-175-E	2NC / 2NO	37,5 m	Quick-Fix QF, remote indicator E
6012999095	SRM-A2Z/U1Z-QF-175-E	3NC / 1NO	37,5 m	Quick-Fix QF, remote indicator E
6012921091	SRM-U1Z/U1Z-LU-300	2NC / 2NO	75 m	Eye LU
6012991100	SRM-A2Z/U1Z-LU-300	3NC / 1NO	75 m	Eye LU
6012921092	SRM-U1Z/U1Z-LU-300-E	2NC / 2NO	75 m	Eye LU, remote indicator E
6012991101	SRM-A2Z/U1Z-LU-300-E	3NC / 1NO	75 m	Eye LU, remote indicator E
6012921089	SRM-U1Z/U1Z-LU-175	2NC / 2NO	37,5 m	Eye LU
6012991098	SRM-A2Z/U1Z-LU-175	3NC / 1NO	37,5 m	Eye LU
6012921090	SRM-U1Z/U1Z-LU-175-E	2NC / 2NO	37,5 m	Eye LU, remote indicator E
6012991099	SRM-A2Z/U1Z-LU-175-E	3NC / 1NO	37,5 m	Eye LU, remote indicator E
6073200007	AS-i SRM-QF-175		37,5 m	Quick-Fix QF, AS-i Safety at Work
6073200008	AS-i SRM-QF-300		75 m	Quick-Fix QF, AS-i Safety at Work
6073200009	AS-i SRM-LU-175		37,5 m	Eye LU, AS-i Safety at Work
6073200010	AS-i SRM-LU-300		75 m	Eye LU, AS-i Safety at Work

* further articles on request; ** temperature dependent – for more information see page 5

SRM-U1Z/U1Z-QF-300-E-...

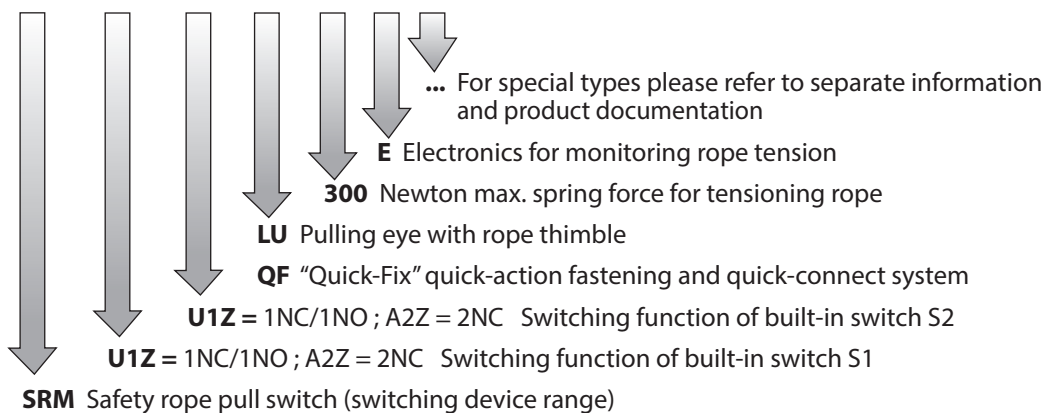

Safety when you need it – SR rope pull switch

The SR rope pull switch provides safety for your machine.

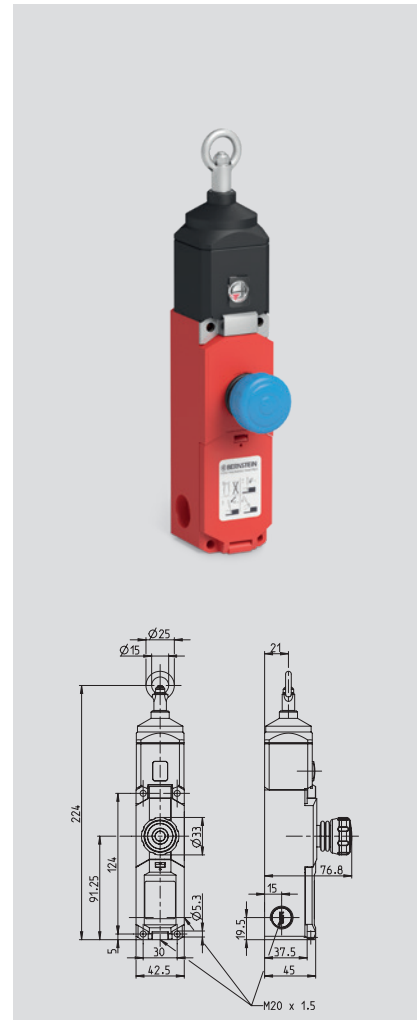
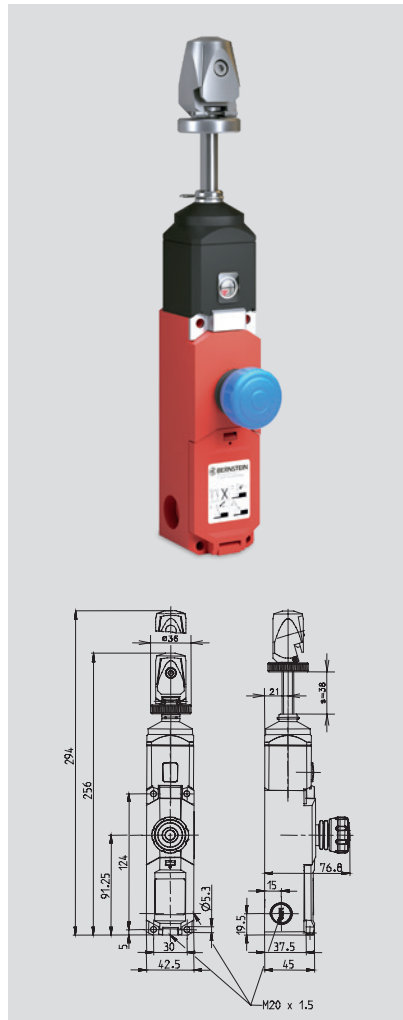
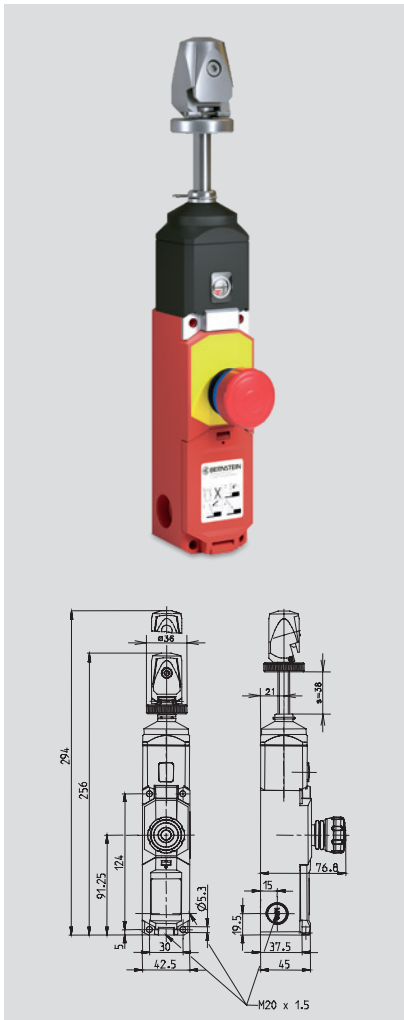

Product description

- Rope pull switch manufactured in accordance with IEC 60947-5-5 and ISO 13850
- Protection class IP67
- Stable and durable plastic housing (PA 6 GV)
- Can be deployed at temperatures between $-25\text{ }^{\circ}\text{C}$ and $+70\text{ }^{\circ}\text{C}$
- Flexible handling with three M20 x 1.5 cable entries
- Easy installation due to the maximum connection space
- Up to four positively driven NC contacts \rightarrow

Technical data SR

- Rated insulation voltage U_i 250 V AC
- Rated operating voltage U_e 240 V
- Utilization category / switching capacity: AC-15, 240 V / 3 A
- Mechanical switching frequency max. $\leq 20/\text{min}$.
- Mechanical service life 1×10^5 switching cycles
- B10d: 1×10^5 million
- Admissible ambient temperature $-25\text{ }^{\circ}\text{C}$ to $+70\text{ }^{\circ}\text{C}$
- Protection class IP67 in accordance with IEC 60529
- Enclosure: glass fibre-reinforced polyamide PA 6

Order data

SR

Article number *	Designation	Contact type	Max. span length **	Features
6011629072	SR-U2Z-0-QF-300-L0-0-0	2NC / 2NO	75 m	Quick-Fix QF
6011691082	SR-A4Z-0-QF-300-L0-0-0	4NC	75 m	Quick-Fix QF
6011629069	SR-U2Z-NA-QF-300-L0-0-0	2NC / 2NO	75 m	Emergency stop NA, Quick-Fix QF
6011691079	SR-A4Z-NA-QF-300-L0-0-0	4NC	75 m	Emergency stop NA, Quick-Fix QF
6011629071	SR-U2Z-0-QF-175-L0-0-0	2NC / 2NO	37,5 m	Quick-Fix QF
6011691081	SR-A4Z-0-QF-175-L0-0-0	4NC	37,5 m	Quick-Fix QF
6011629068	SR-U2Z-NA-QF-175-L0-0-0	2NC / 2NO	37,5 m	Emergency stop NA, Quick-Fix QF
6011691078	SR-A4Z-NA-QF-175-L0-0-0	4NC	37,5 m	Emergency stop NA, Quick-Fix QF
6011629070	SR-U2Z-0-QF-100-L0-0-0	2NC / 2NO	25 m	Quick-Fix QF
6011691080	SR-A4Z-0-QF-100-L0-0-0	4NC	25 m	Quick-Fix QF
6011629067	SR-U2Z-NA-QF-100-L0-0-0	2NC / 2NO	25 m	Emergency stop NA, Quick-Fix QF
6011691077	SR-A4Z-NA-QF-100-L0-0-0	4NC	25 m	Emergency stop NA, Quick-Fix QF
6011621066	SR-U2Z-0-LU-300-L0-0-0	2NC / 2NO	75 m	Eye LU
6011691076	SR-A4Z-0-LU-300-L0-0-0	4NC	75 m	Eye LU
6011621065	SR-U2Z-0-LU-175-L0-0-0	2NC / 2NO	37,5 m	Eye LU
6011691075	SR-A4Z-0-LU-175-L0-0-0	4NC	37,5 m	Eye LU
6011621064	SR-U2Z-0-LU-100-L0-0-0	2NC / 2NO	25 m	Eye LU
6011691074	SR-A4Z-0-LU-100-L0-0-0	4NC	25 m	Eye LU

* further articles on request; ** temperature dependent – for more information see page 5

SR-U2Z-NA-QF-175-L0-K5.5-...

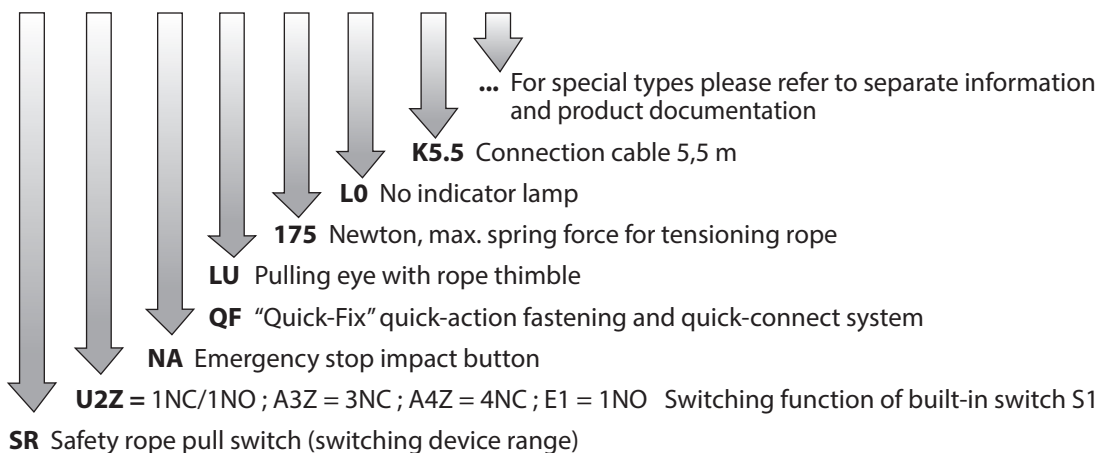



Contact

International Headquarters BERNSTEIN AG

Hans-Bernstein-Str. 1
32457 Porta Westfalica
Phone +49 571 793-0
Fax +49 571 793-555
info@de.bernstein.eu
www.bernstein.eu

Denmark BERNSTEIN A/S

Phone +45 7020 0522
Fax +45 7020 0177
info@dk.bernstein.eu

France BERNSTEIN S.A.R.L.

Phone +33 1 64 66 32 50
Fax +33 1 64 66 10 02
info@fr.bernstein.eu

Italy BERNSTEIN S.r.l.

Phone +39 035 4549037
Fax +39 035 4549647
info@it.bernstein.eu

United Kingdom BERNSTEIN Ltd

Phone +44 1922 744999
Fax +44 1922 457555
info@uk.bernstein.eu

Austria BERNSTEIN GmbH

Phone +43 2256 62070-0
Fax +43 2256 62618
info@at.bernstein.eu

Switzerland BERNSTEIN (Schweiz) AG

Phone +41 44 775 71-71
Fax +41 44 775 71-72
info@ch.bernstein.eu

Hungary BERNSTEIN Kft.

Phone +36 1 4342295
Fax +36 1 4342299
info@hu.bernstein.eu

China BERNSTEIN Safe Solutions (Taicang) Co., Ltd.

Phone +86 512 81608180
Fax +86 512 81608181
info@bernstein-safesolutions.cn

www.bernstein.eu